



Using the THEMIS energetic Particle Data

Davin Larson Space Science Lab; Berkeley

Thomas Moreau

THEMIS Mission

- 5 identical spacecraft in highly elliptical orbits (1,2 &4 day periods)
- Each spacecraft has 5 instruments:
 - FGM – Flux Gate Magnetometer
 - SCM – Search Coil Magnetometer
 - EFI - Electric Field Instrument (DC and AC)
 - ESA - Electrostatic Analyzer
 - SST - Solid State Telescope

SST Instrument Description Summary

- Solid State Telescopes:
 - Measure Energetic Electrons and Ions
 - Energy Range:
 - H+: 25 keV to 6 MeV
 - Electrons 25 keV to ~900 keV
 - Angular Coverage:
 - Theta
 - 4 look directions (+55, +25, -25, -55)
 - Resolution: ~ 30 deg FWHM
 - Phi
 - 32 sectors
 - Resolution: ~20 deg FWHM
 - Geometric Factor: ~0.1 cm²-ster (~1/3 of WIND)
 - Mechanical Pinhole Attenuator: Lowers geometric factor by ~64

SST Principle of Operation

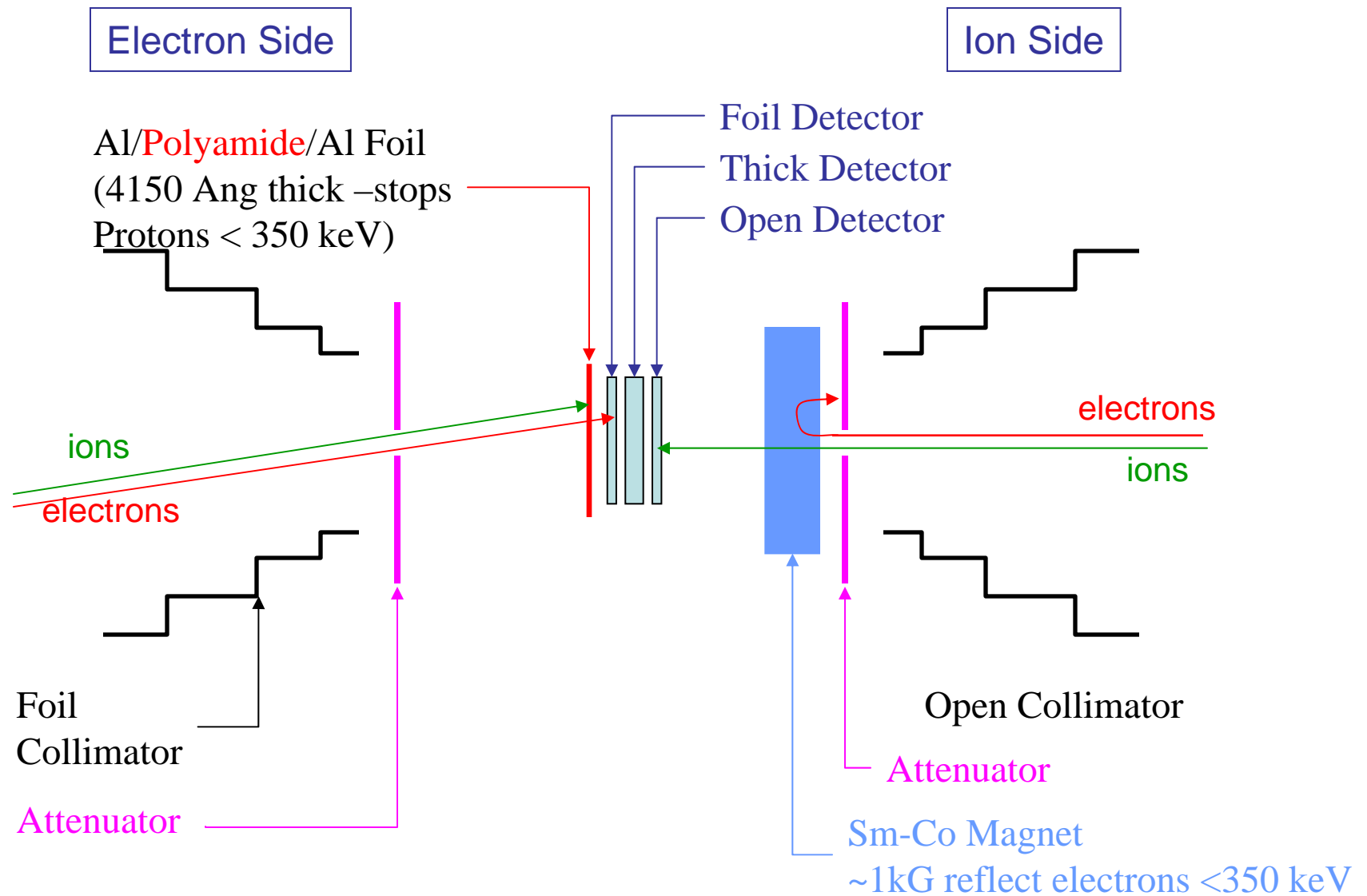

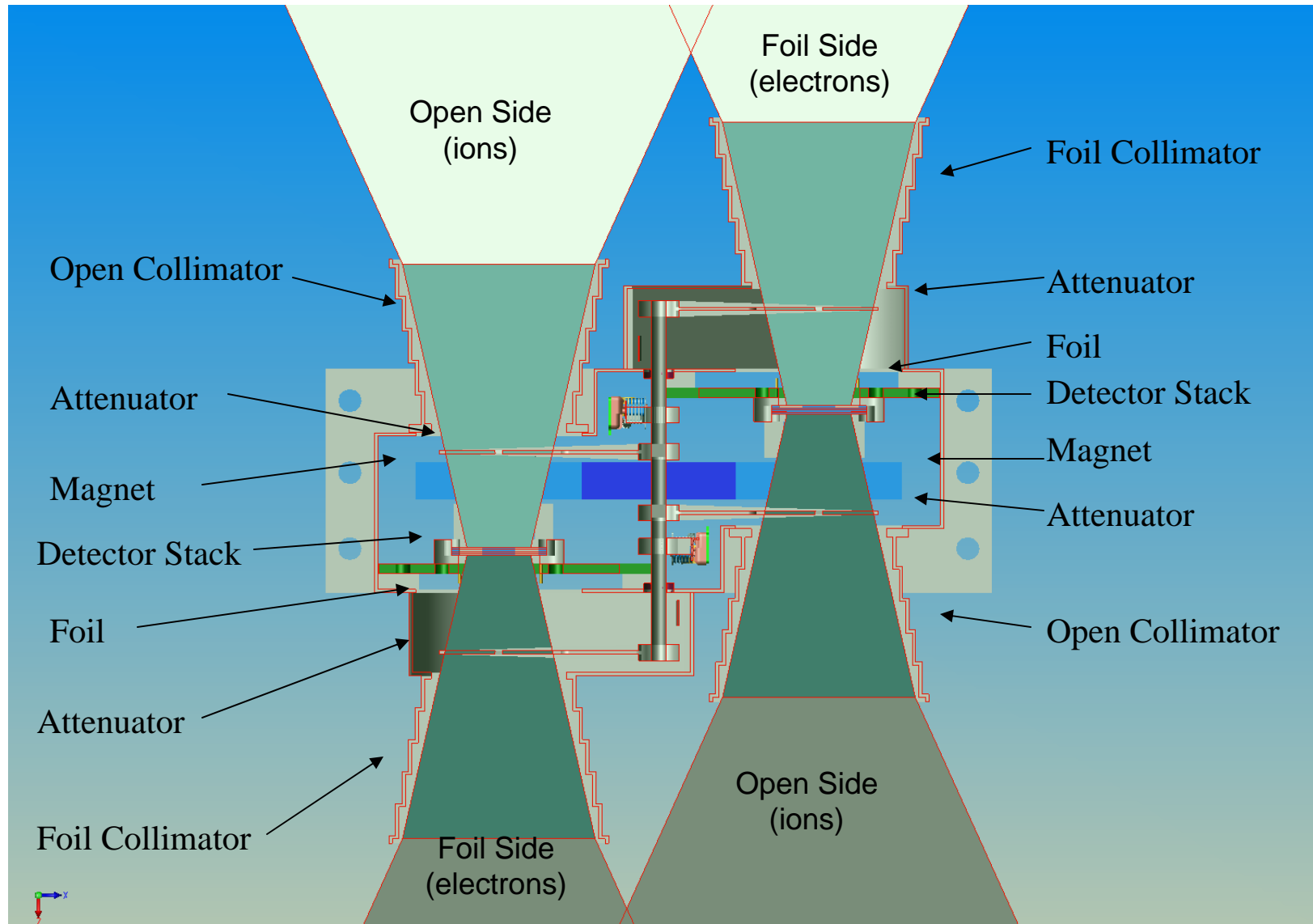

Types of detector events

- With a stack of 3 detectors there are 7 types of coincident events:
 - F - Single event in Foil detector (electrons <350 keV, ions >350 keV)
 - O - Single event in Open detector (protons <350 keV, electrons > 350 keV)
 - T - Single event in Thick detector (xrays, scattered electrons)
 - FT – Double event in Foil & Thick (electrons 350 -600 keV)
 - OT – Double event in Open & Thick (Ions > 6 MeV)
 - FTO – Triplet event – (electrons < 1MeV, protons >10 MeV)
 - FO - Treated as separate F and O events.
 - Of the 16 energy channels the first 12 are devoted to singlet events. The last 4 channel record multiples.

SST Mechanical

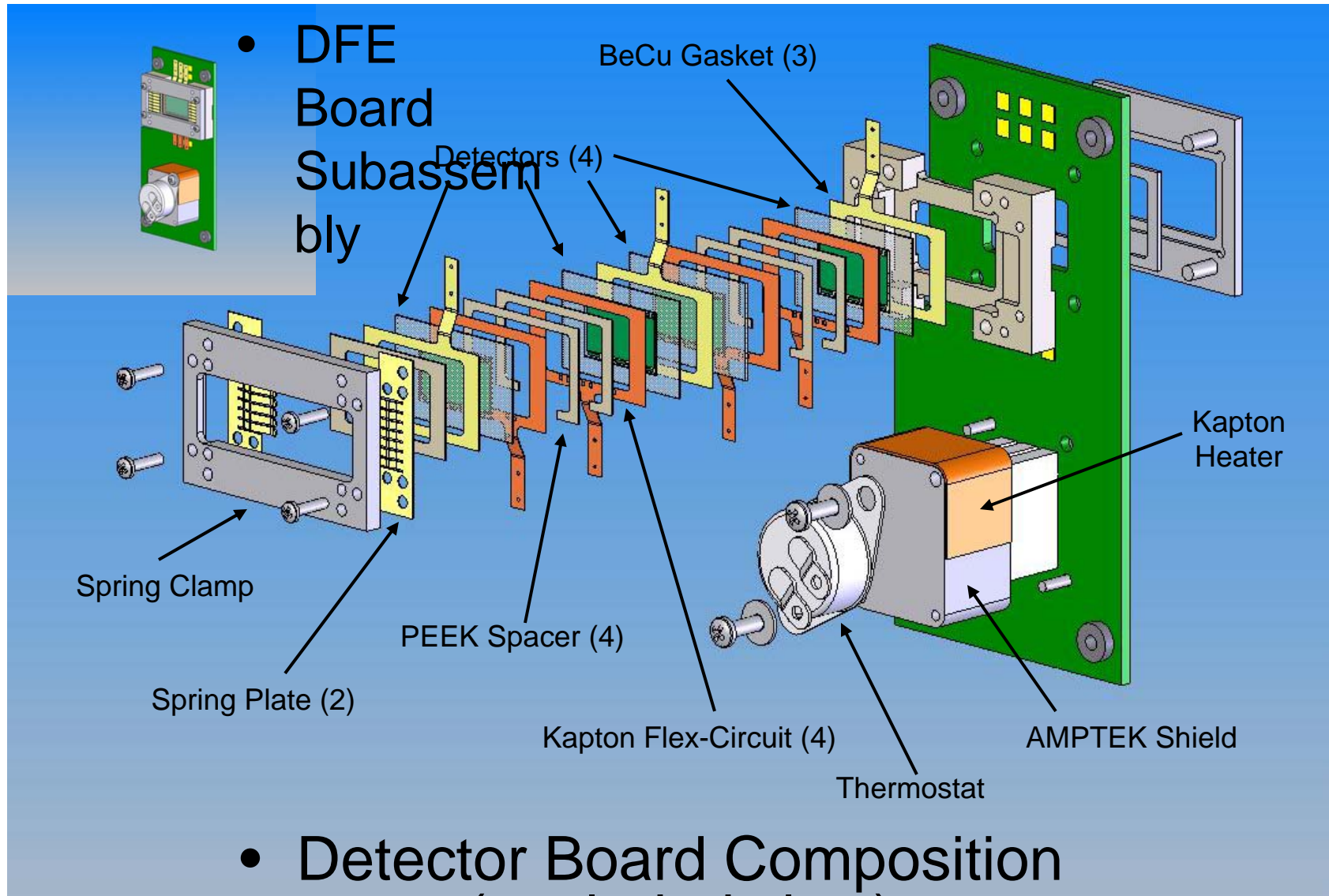

- Detector Board Composition (exploded view)

SST Mechanical

- Actuators and Position Switches

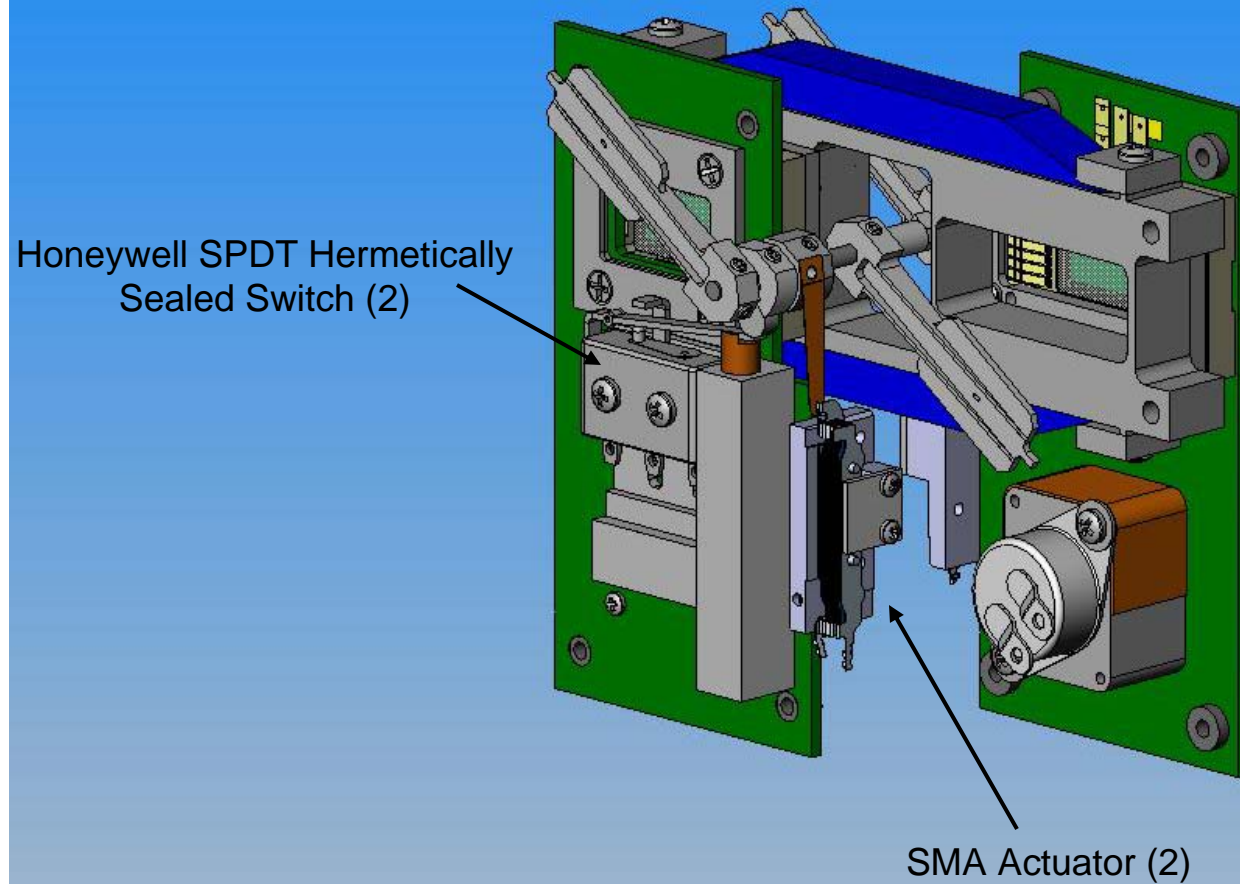

SST Mechanical

- Support Structure
- (front section)

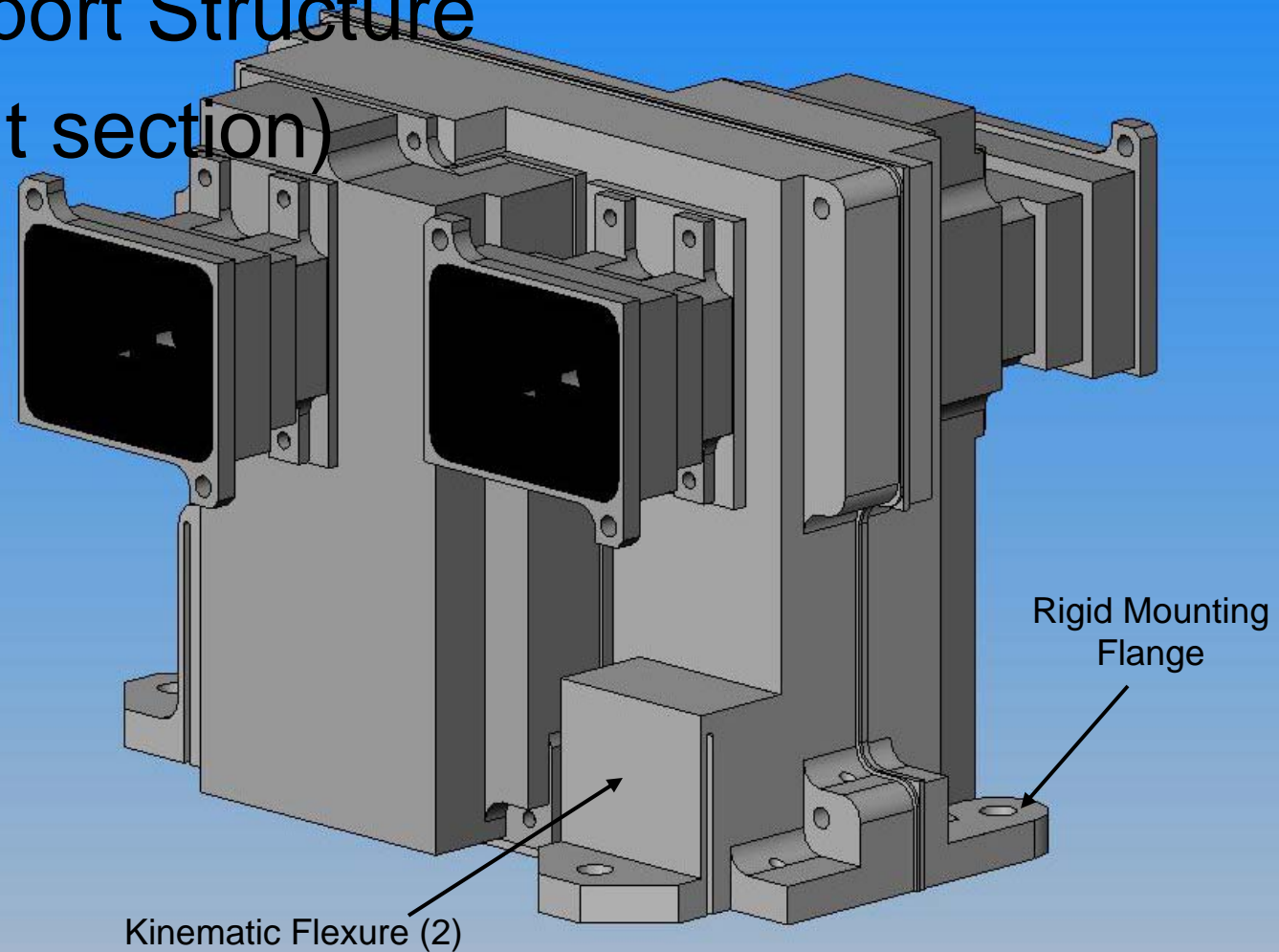

SST Mechanical

- Bi-Directional Fields-of-View

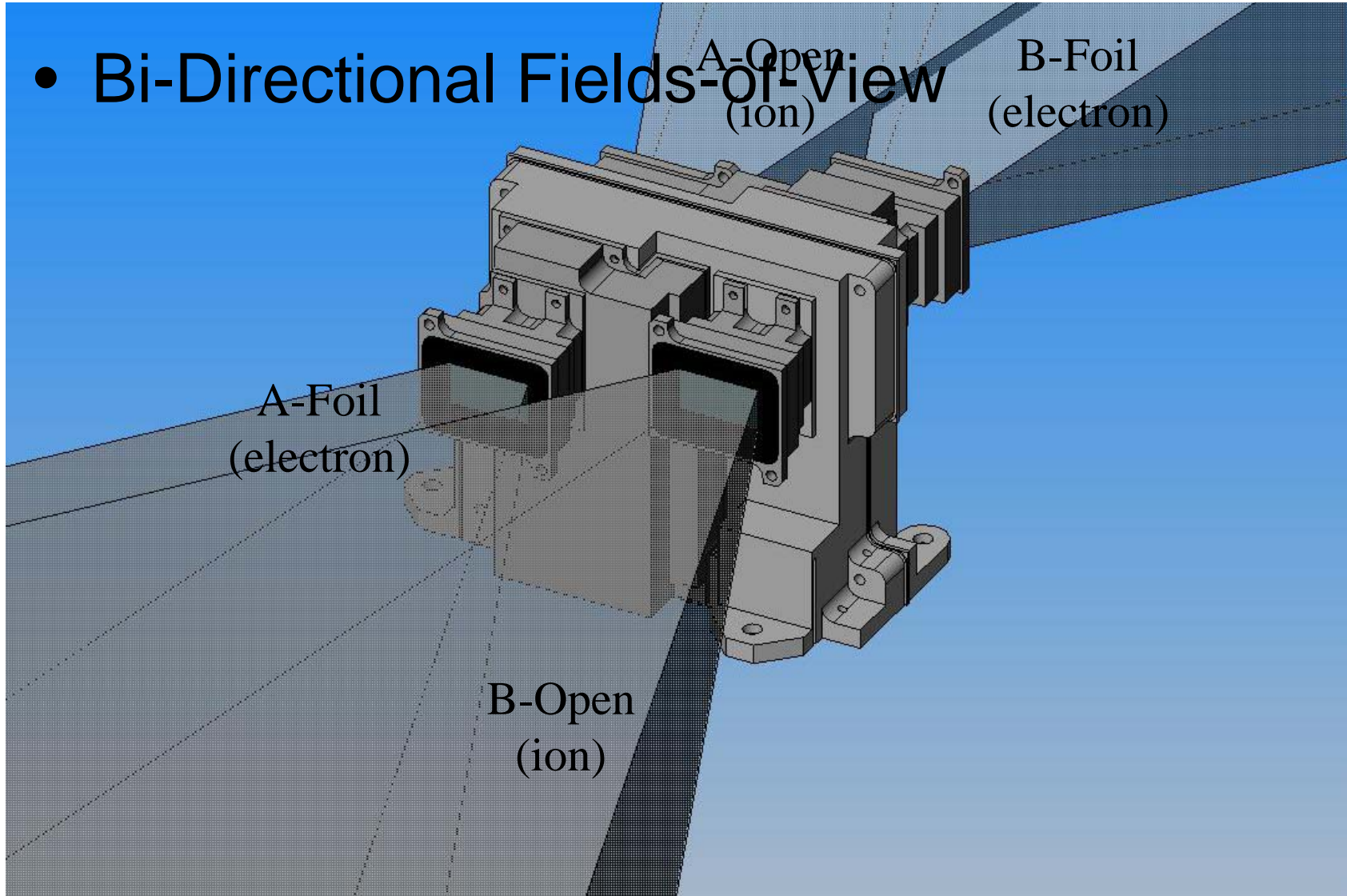

SST Mechanical Design

- Sensor Orientation Relative to Spacecraft Bus

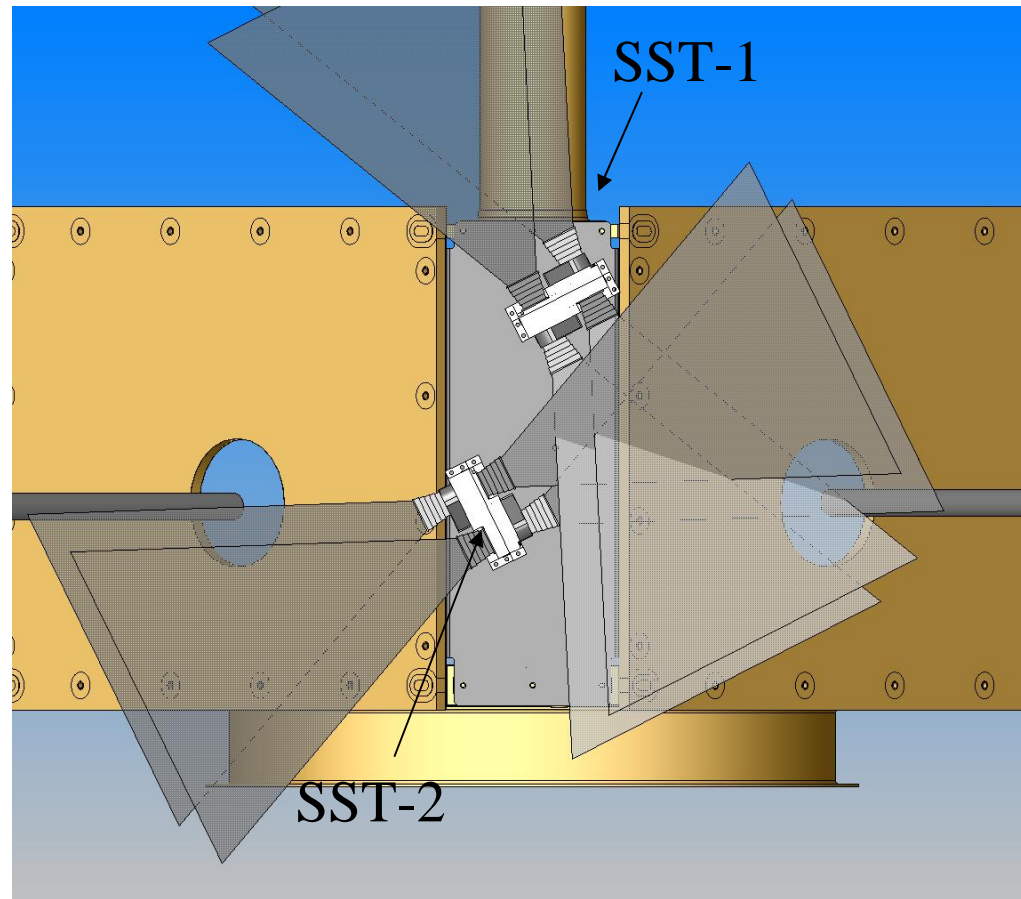

SST Mechanical

- Attenuator Actuation – CLOSED position

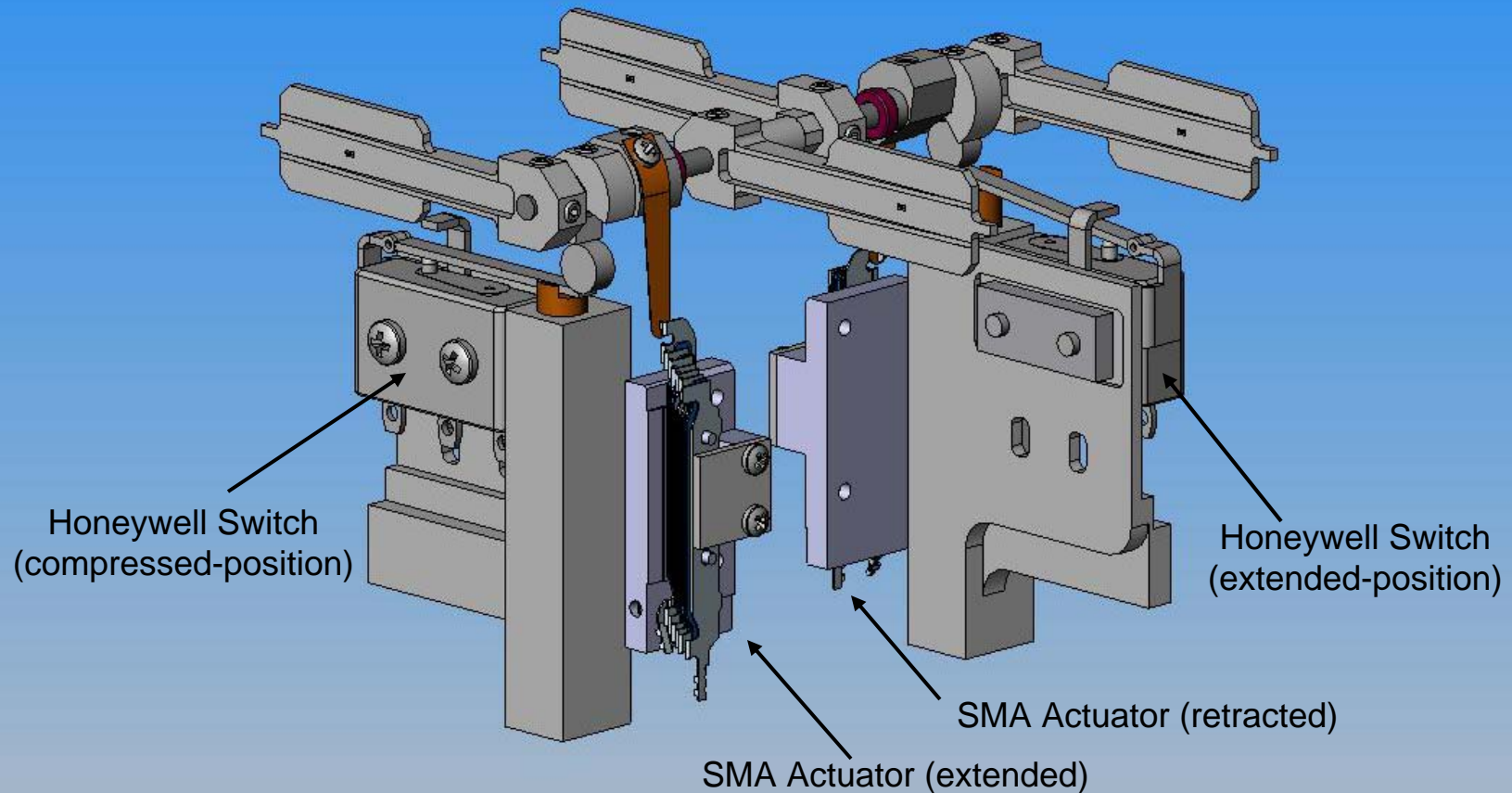

SST Mechanical

- Attenuator Actuation – OPEN position

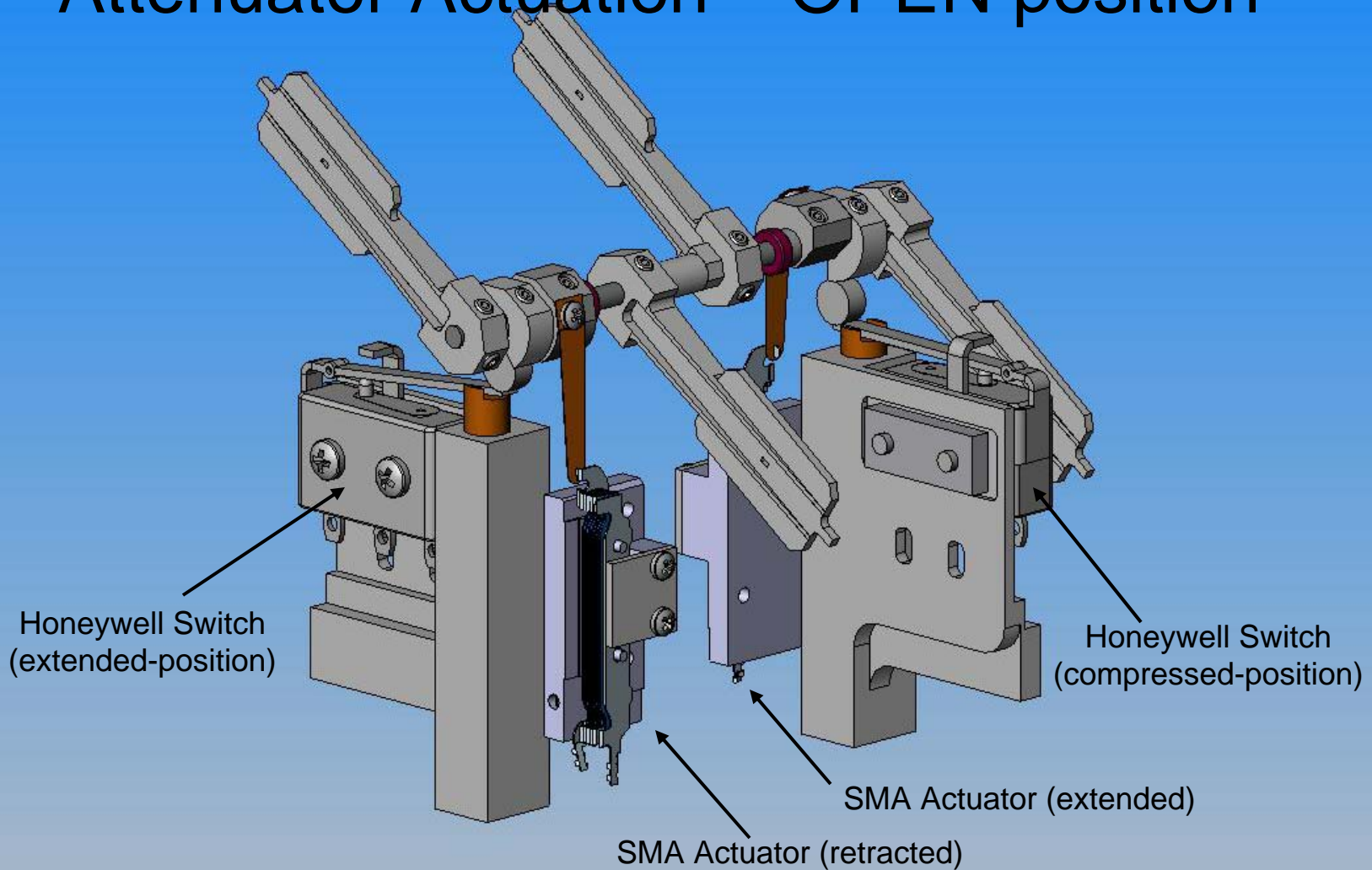

Instrument Configuration

- Instrument Configuration
 - The SST Energy bins are controlled by DAP table.
 - Can be reconfigured with table upload.
 - Precision: $6 \text{ MeV}/4096 = 1.5 \text{ keV}$
 - Default configuration is ~log spaced
 - Only 1 mode currently defined.
 - The SST 3D (angular) distributions are binned by ETC angle map.
 - 5 angle maps defined:
 - 1 angle (omni)
 - 6 angle (RDF)
 - 32 angle
 - 64 angle (burst, FDF)
 - 128 angle (LEO, testing)

SST Calibration

- Prelaunch calibration of Electron sensors.
 - Prelaunch electron energy calibration consisted of detector response to low energy mono-energetic electron beam with unknown absolute particle flux.
 - Electron beam energy varied in 1 keV steps from 15 keV to E_{max} .
 - Every attempt was made to keep electron beam flux constant with energy.
 - Max electron energy was typically limited to ~40-44 keV due to unexpected discharges within the electron gun at higher voltages.
 - Prelaunch geometric factor was determined by calculation based on collimator acceptance angle and active detector area.
 - The geometric factor had been assumed to be independent of energy.
- Prelaunch calibration of ion sensors
 - Prelaunch ion calibration consisted of detector response to mono-energetic protons and oxygen with unknown absolute (or relative) particle flux.
 - Max energy at SSL Calibration facility was 50 keV (~45 keV on low humidity days). Absolute Flux was unknown and varied in an unknown way with energy.
 - Calibration of 1 ½ sensors performed at APL (many thanks to Stefano Levi and George Ho) allowed response to be measured up to 170 keV for both oxygen and protons.

SST Post Launch Calibration

– Post flight calibration issues:

- Slow realization (and acceptance) that sensors have significant energy dependent geometric factor correction at low energy.
- Degradation in energy response due to radiation damage. This takes on two forms:
 - Low energy ions that implant in the first few thousand Angstroms tend to increase the dead layer and result in a shift in energy.
 - High energy (MeV) ions that pass through the bulk of the detector creating dislocations and recombination sites that reduce the resulting charge pulse. This tends to reduce the gain of the detector.
- Need to account for low energy tail of energy response that has significant effect as the spectral slope changes (not yet done)
- Account for *small* non linearity in ADC circuit that affects low energy portion of spectrum for both ions and electrons.

Caveats when using SST data

- Saturation at high count rates (>20 kHz/channel)
- Sun Pulse
 - Once per spin
 - Affects all channels
 - Easily removed if FULL dists are used
- Low energy electron geometric factor caused by scattering by foil
- Ion detectors – Increasing Dead layer vs time.
- Cross Species contamination
 - Only important when flux of >400 keV particles becomes significant (inner magnetosphere)
- Attenuator state (64x)
 - Closed within inner magnetosphere (<10 Re)
 - Controlled by count rate in outer MS
- We know there is a substantial difference in measured flux as compared with LANL! (~10)

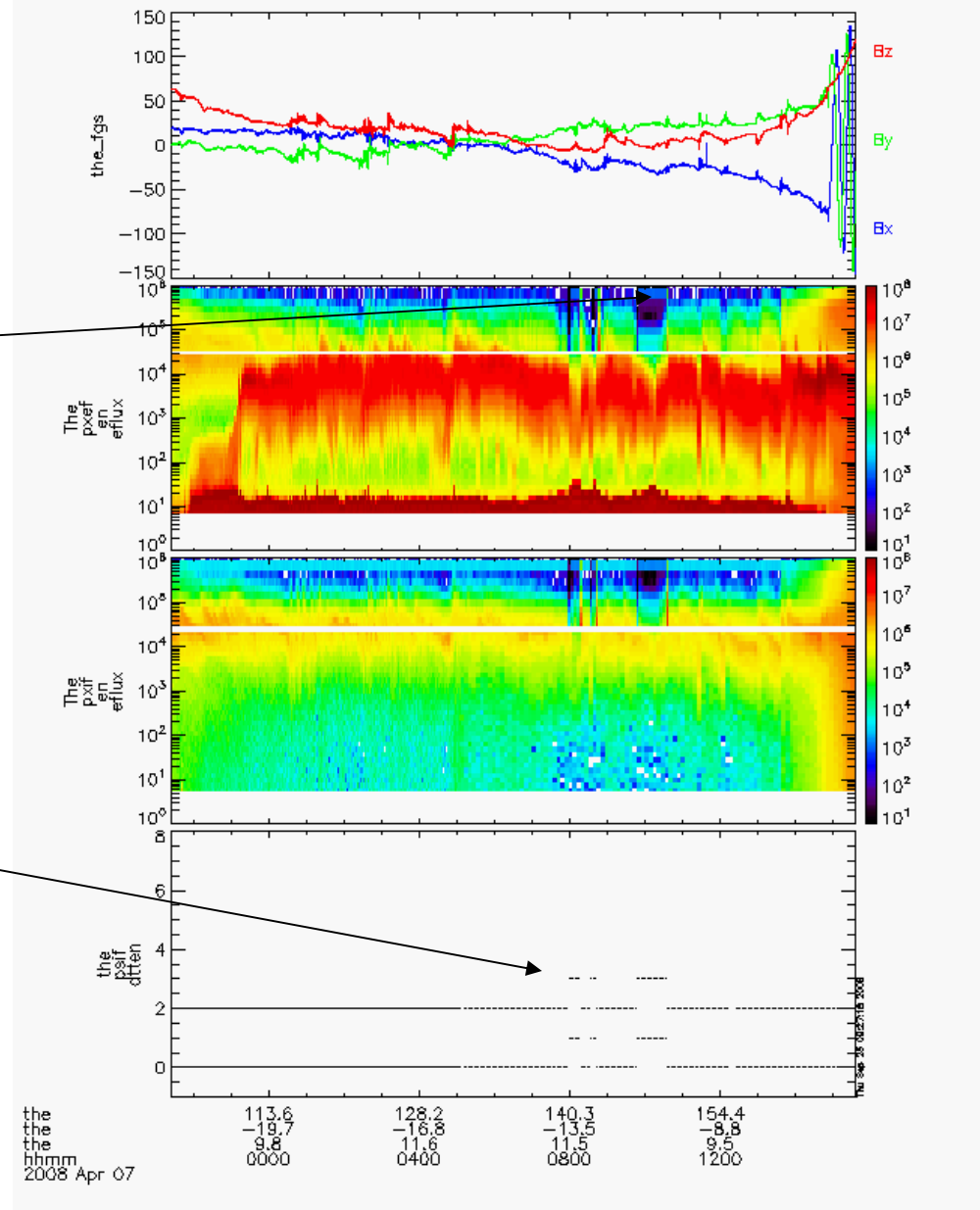

Sunlight Contamination

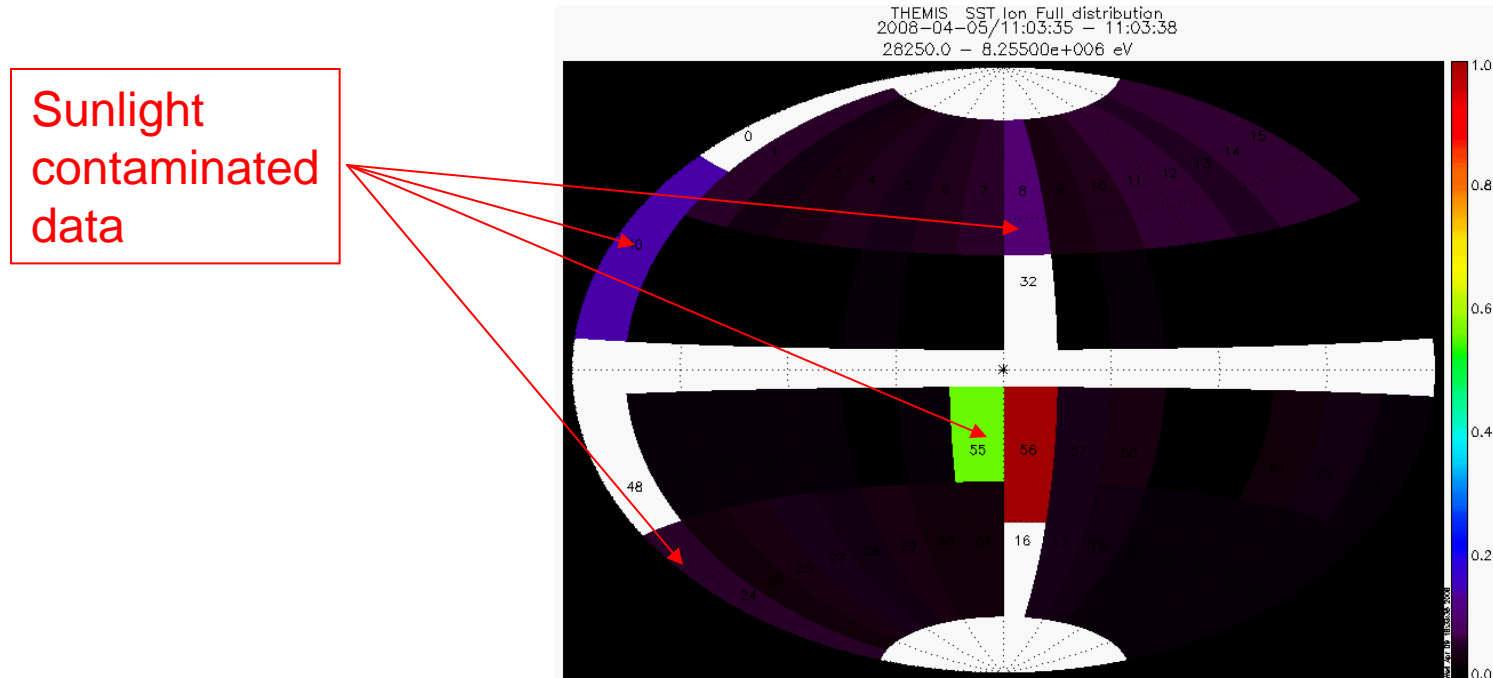

- When an Open detector sees the sun (once per spin) a voltage spike produce “garbage” counts in ALL channels.
- On spacecraft B&C some extra bins were incorrectly masked (zeroed) during most of 2008 tail season
- Data should be replaced with interpolated data from adjacent bins
- See “thm_crib_sst_contamination.pro” for more info

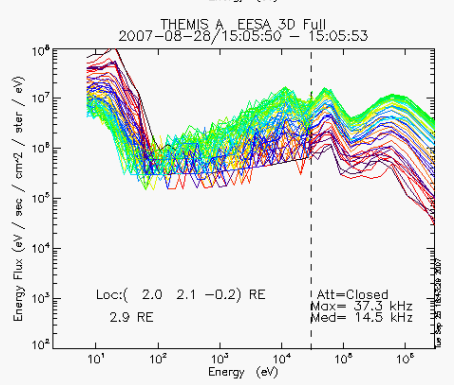
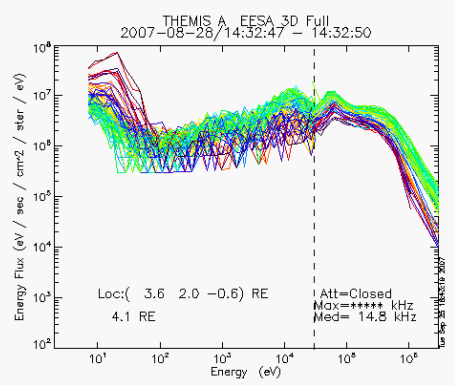
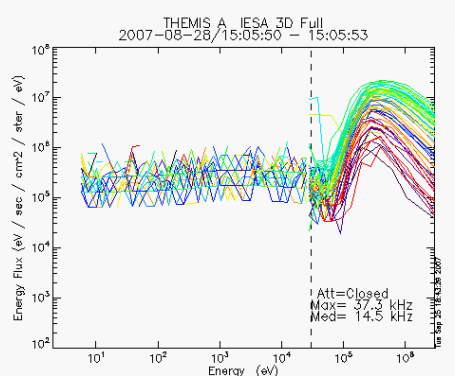
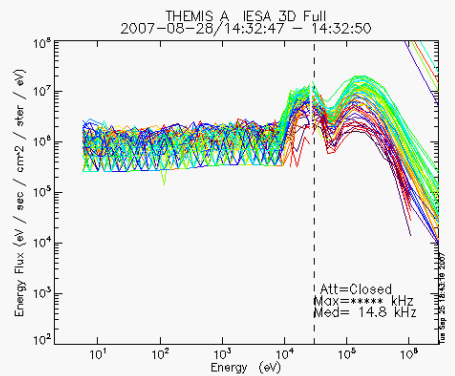
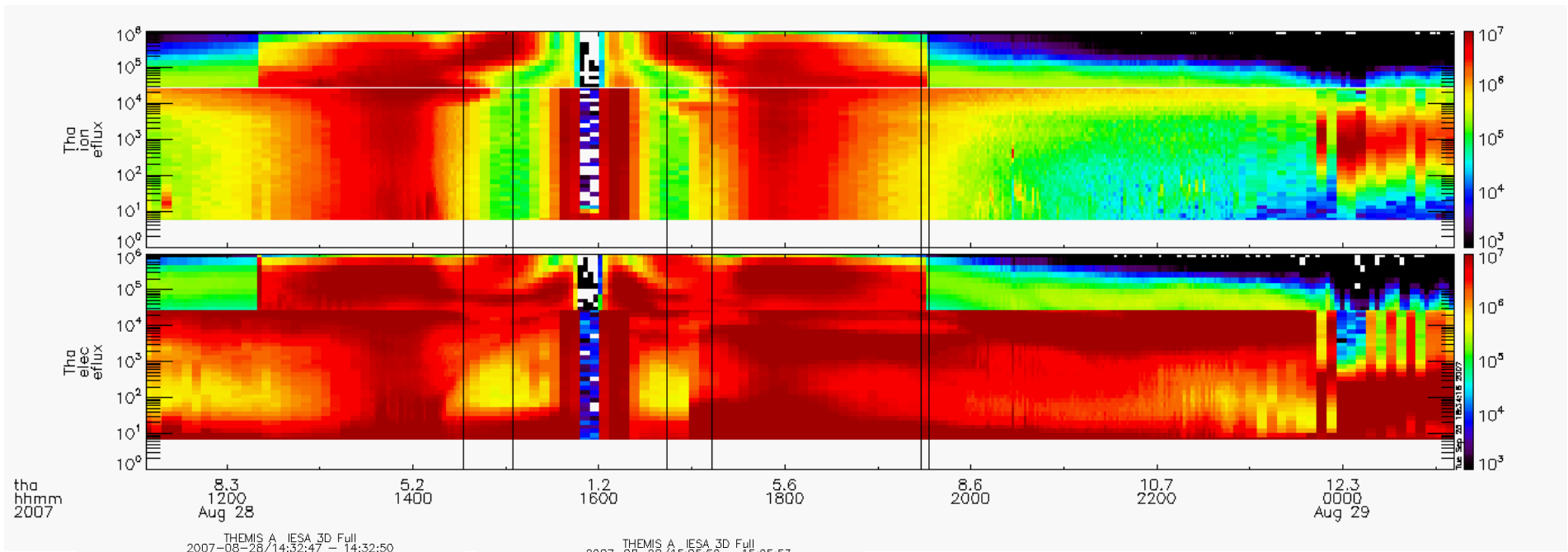

THEMIS A Radiation Belts – Typical pass

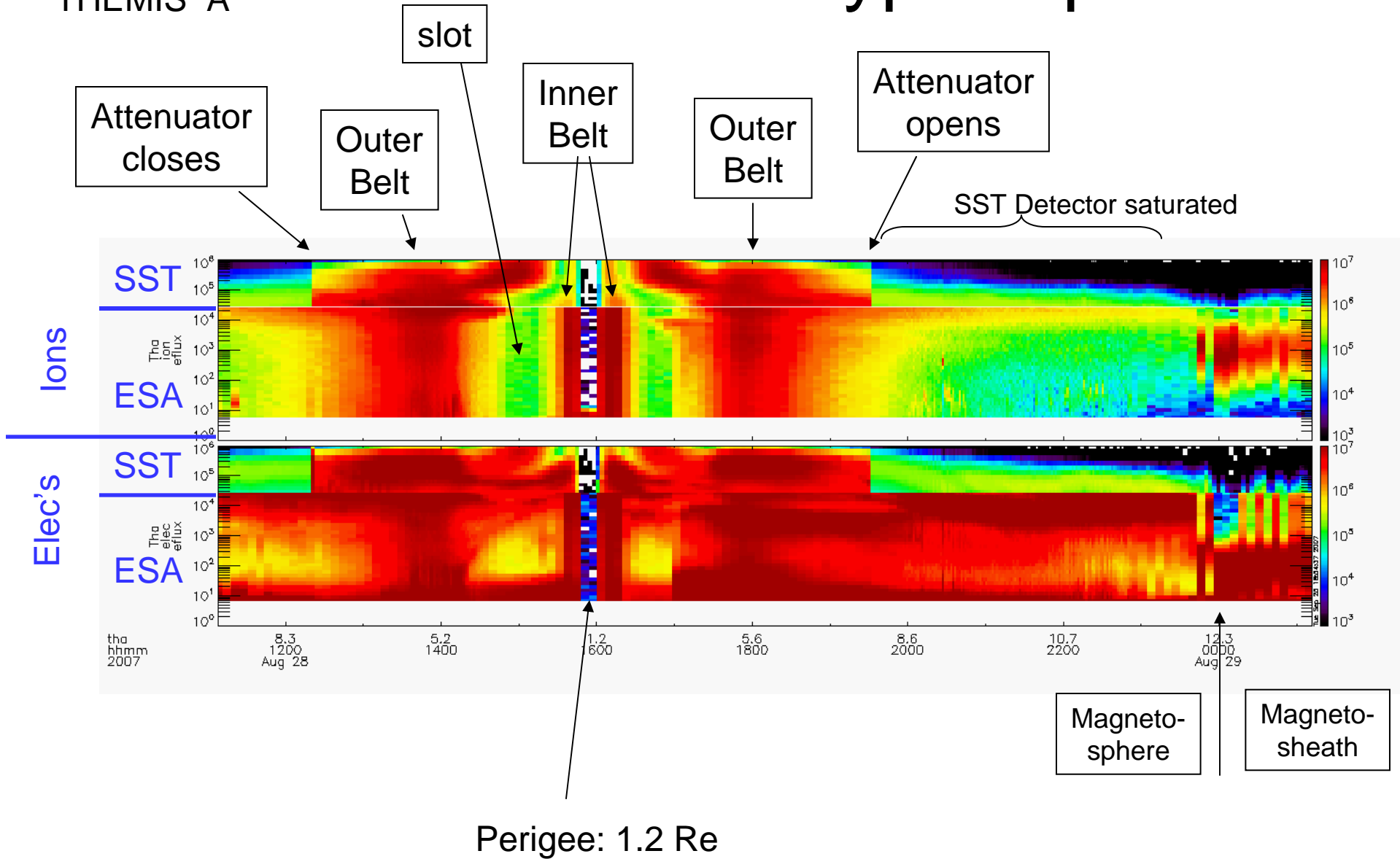

Not corrected for species cross contamination

Radiation Belts – Sample Spectra

THEMIS A

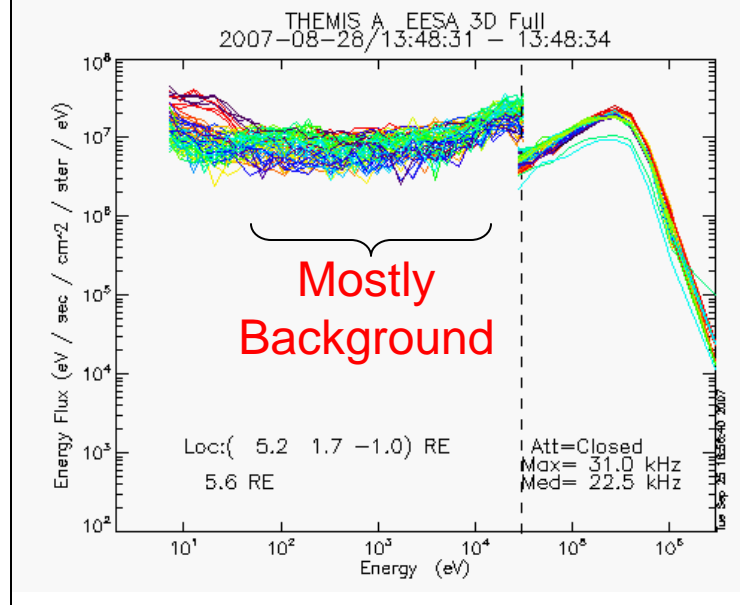
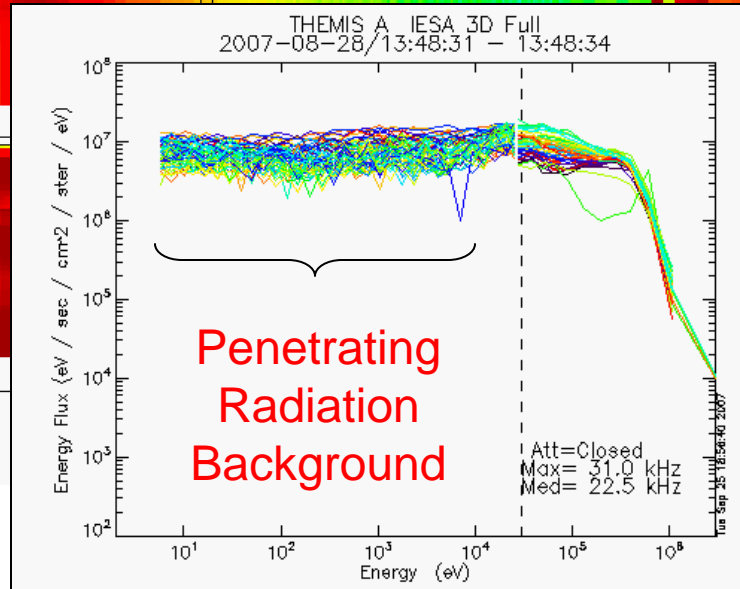
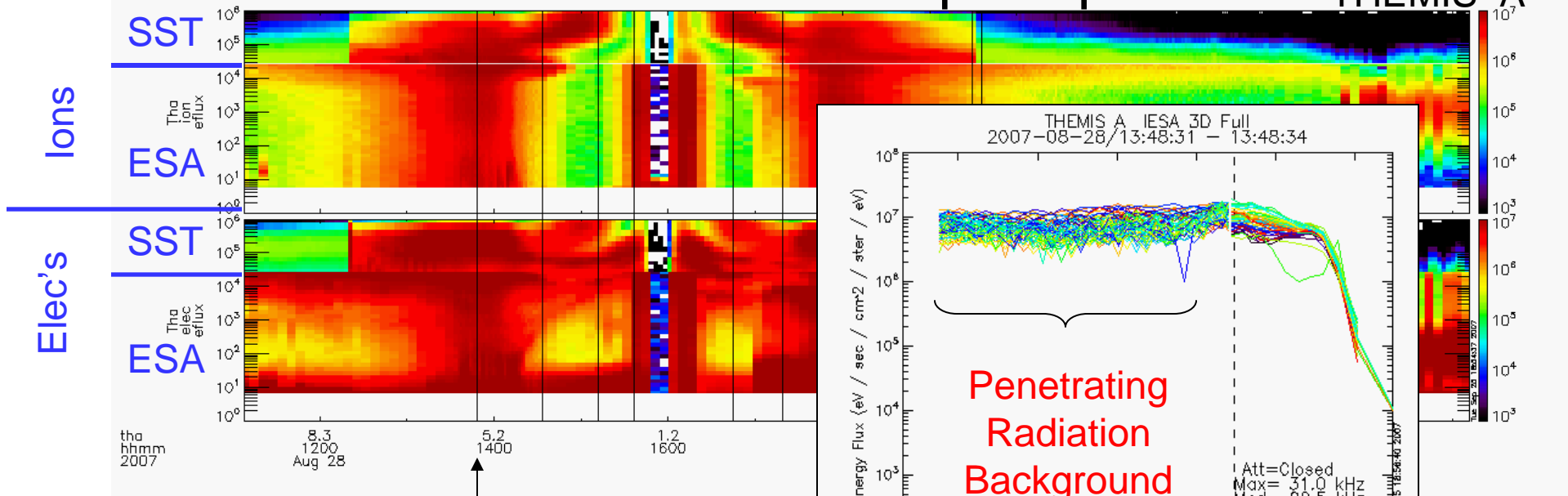

**Outer Belt-
Beware!**

Not corrected for species cross contamination

Radiation Belts – Sample Spectra

THEMIS A

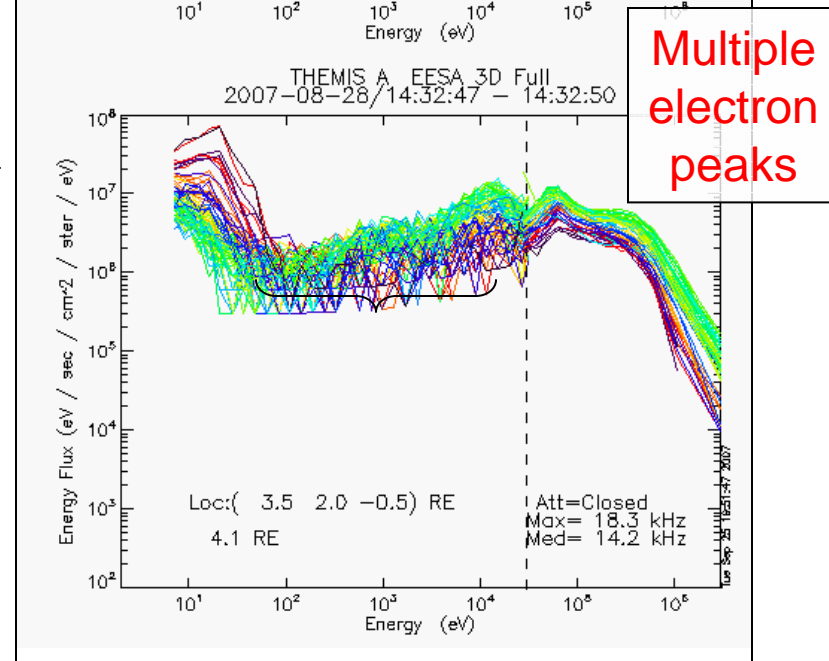
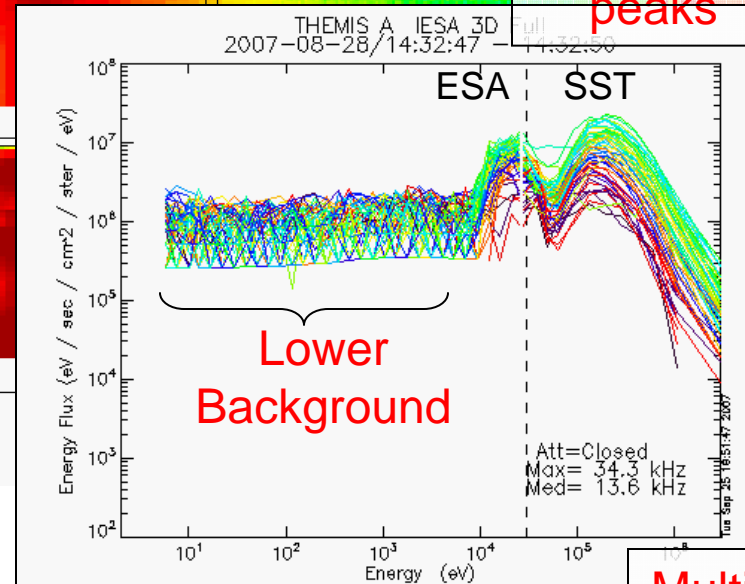
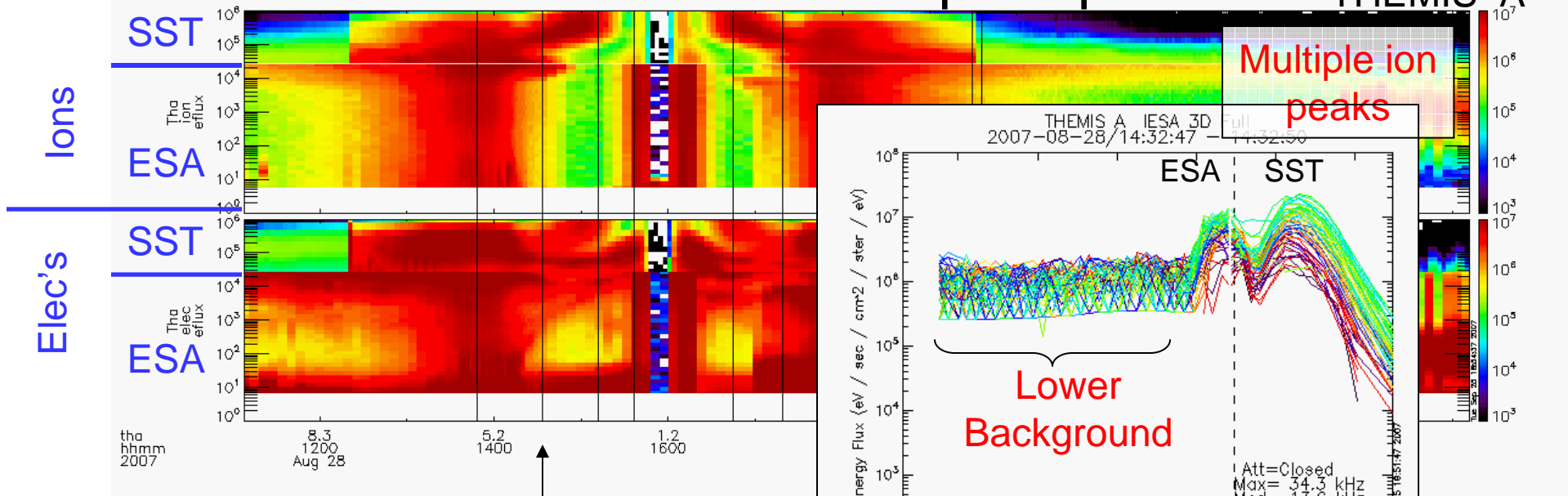

Slot
Multiple Energy peaks
Are common

Not corrected for species cross contamination

Radiation Belts – Sample Spectra

THEMIS A

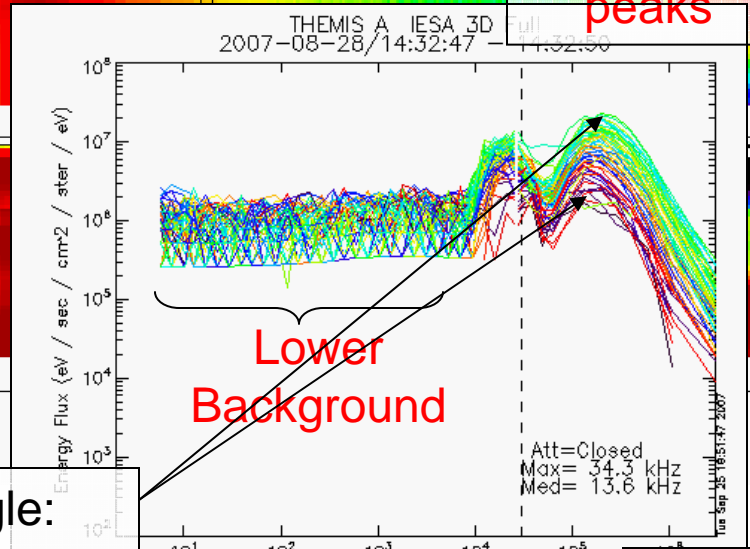
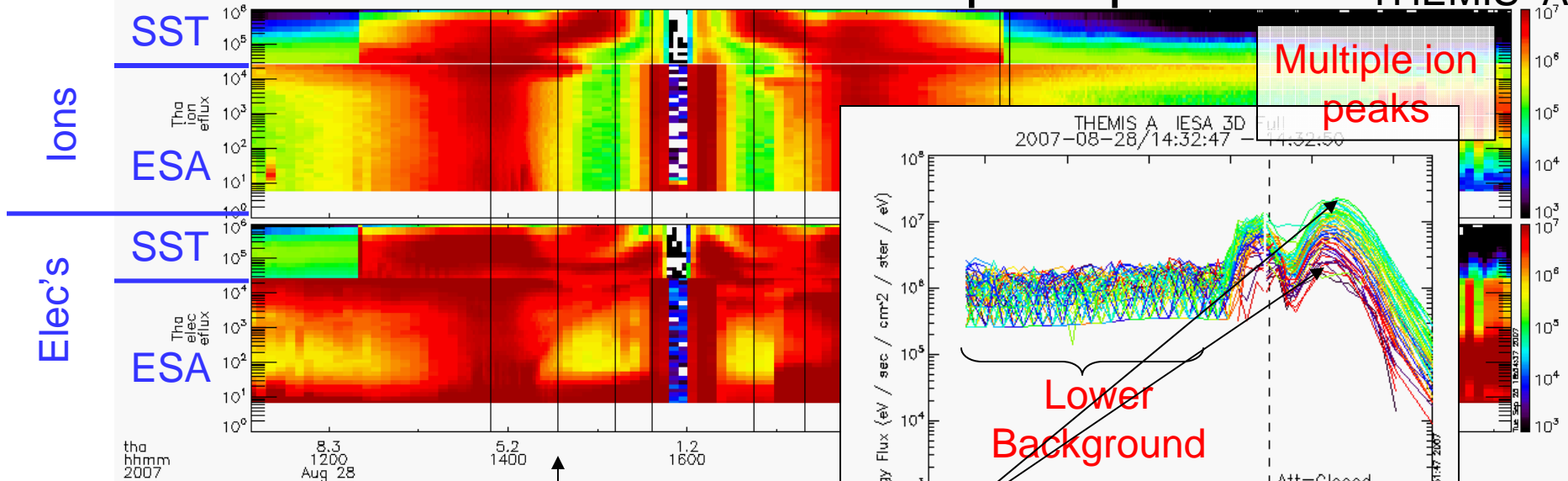

Color Coding by pitch angle:
 Red: 0°
 Green: 90°
 Blue: 180°

Slot
 Multiple Energy peaks
 Are common

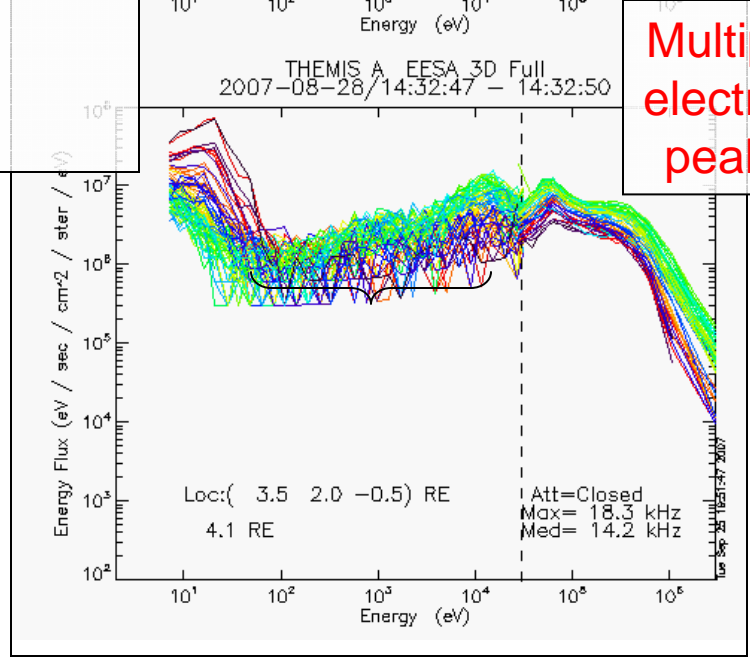

Not corrected for species cross contamination

Radiation Belts – Sample Spectra

THEMIS A

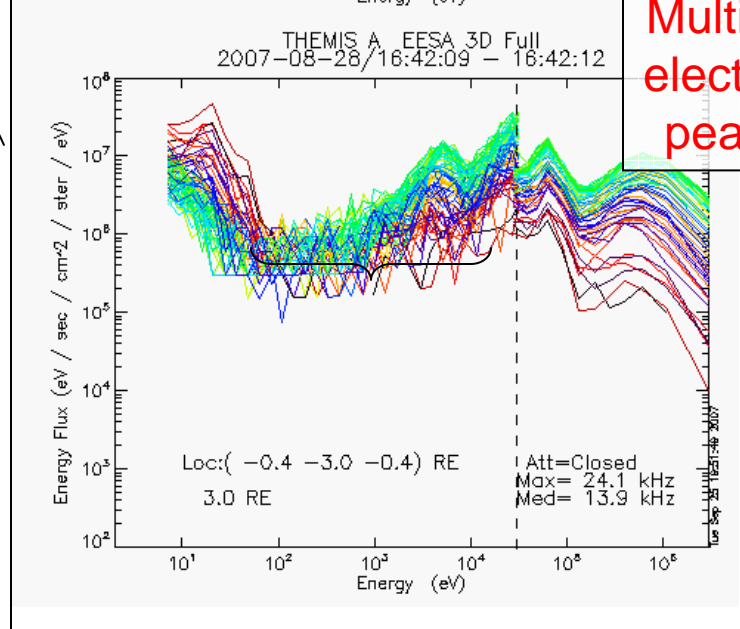
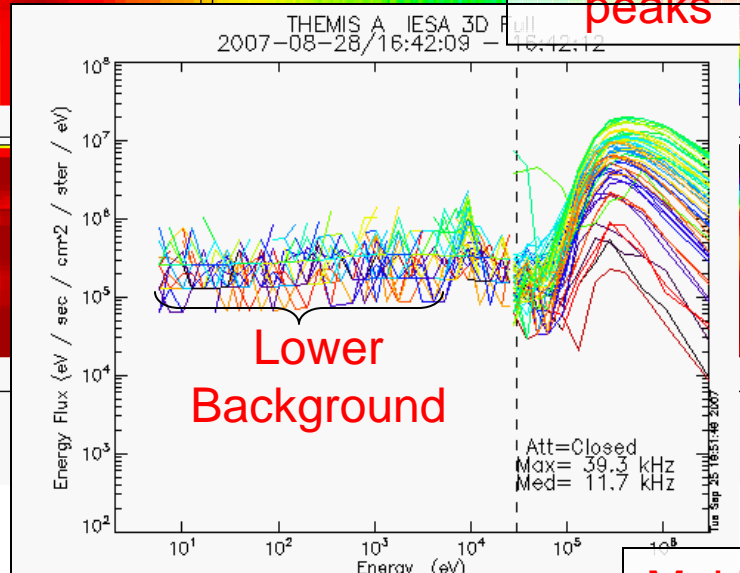
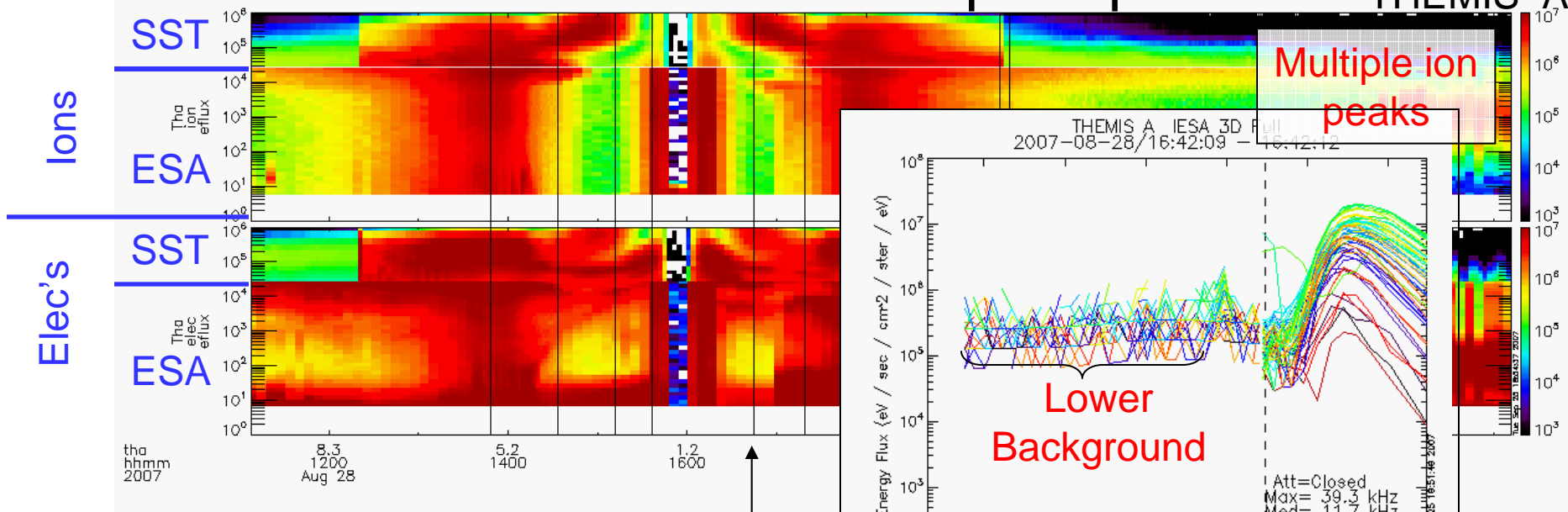

Slot
Multiple Energy peaks
Are common

Outer Belt

Not corrected for species cross contamination

Radiation Belts – Sample Spectra

THEMIS A

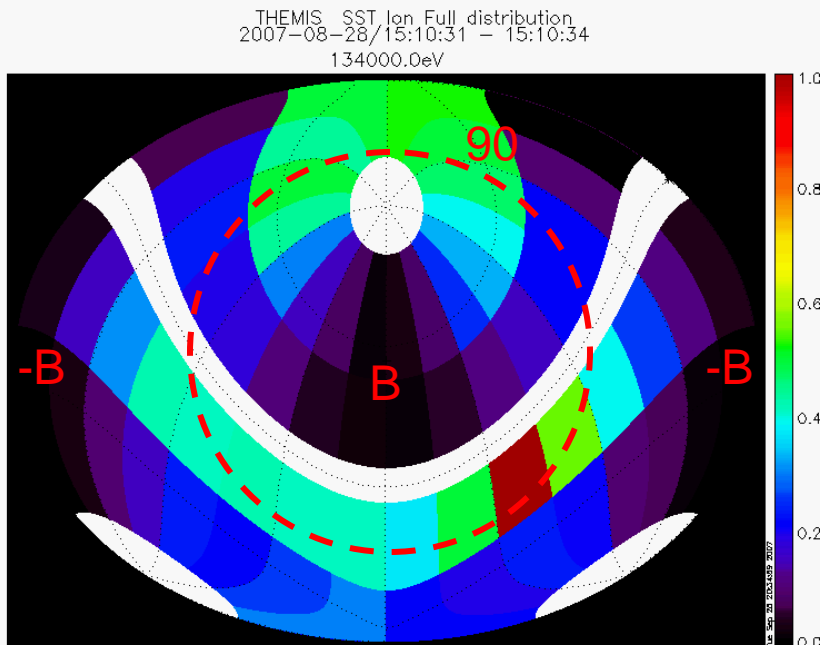
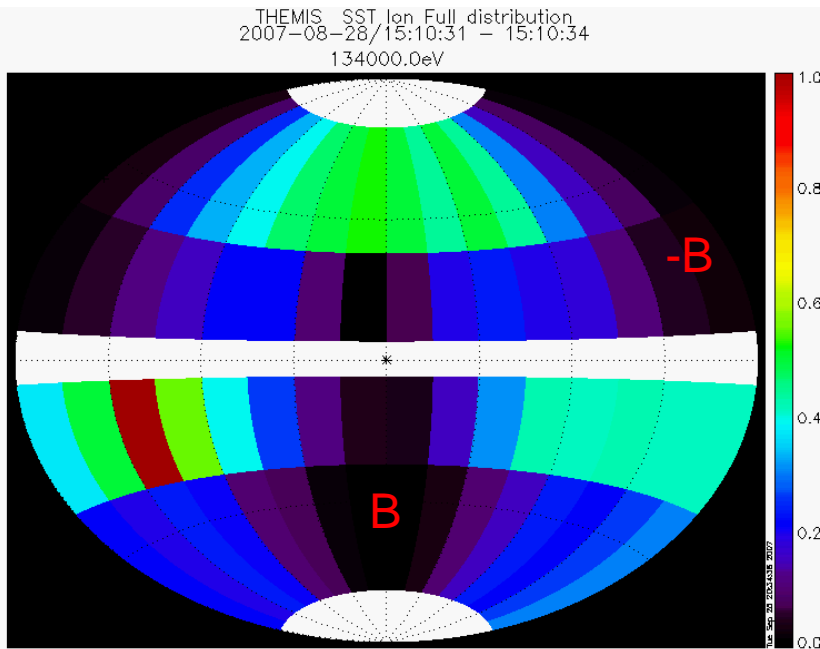

Cut at 134 keV

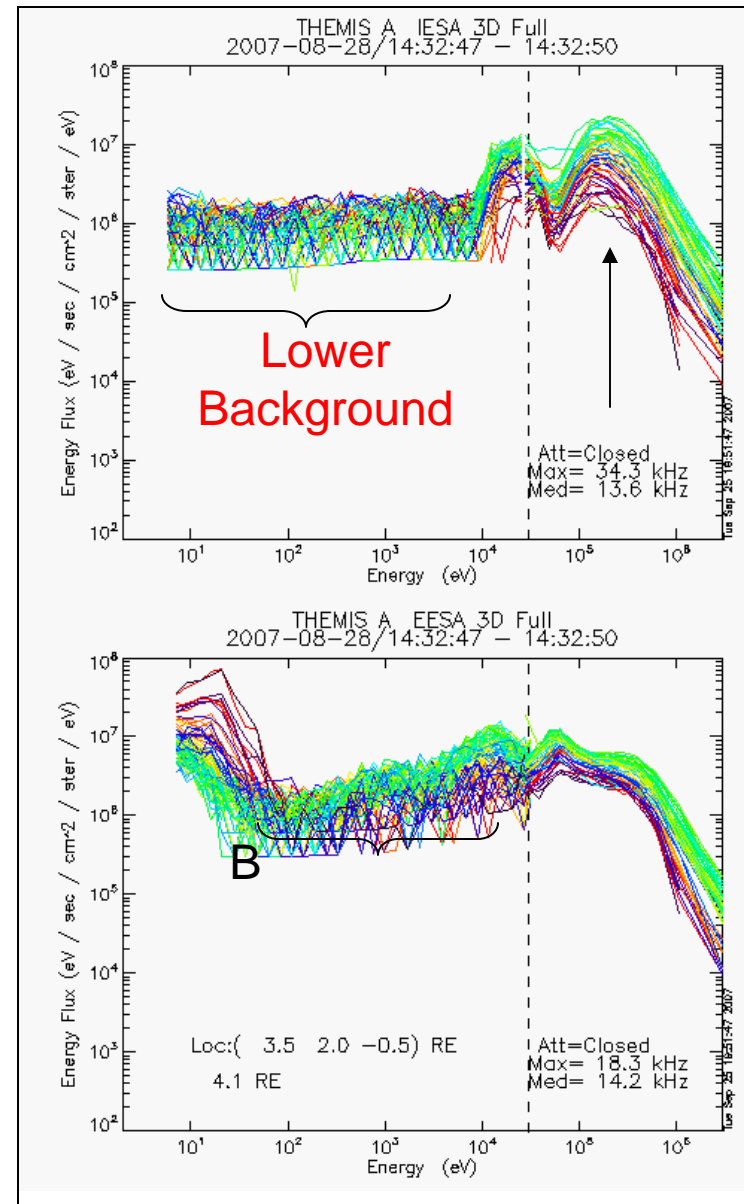

Not corrected for species cross contamination

SST Calibration

- Calibration Efforts:

- In-flight:

- Search for Steady periods of moderately high flux with single energy distribution (as Maxwellian as possible).
 - Calibration is based on comparison with ESA particle spectrum and extrapolation to higher energy
 - For Ions:
 - Use model of dead layer to determine energy shift for each detector (elevation angle)
 - For Electrons:
 - Determine relative geometric factor based on comparison with ESA electron spectrum.

- Ground Calibration:

- Just beginning ion implantation experiment with Jeff Beeman at LBL using ion beam implantation machine.
 - Modeling electron scattering (defocusing) using GEANT4

GEANT4 Modeling

- We have created a partial 3D simulation model using GEANT4 to help determine instrument response to scattered and penetrating particles

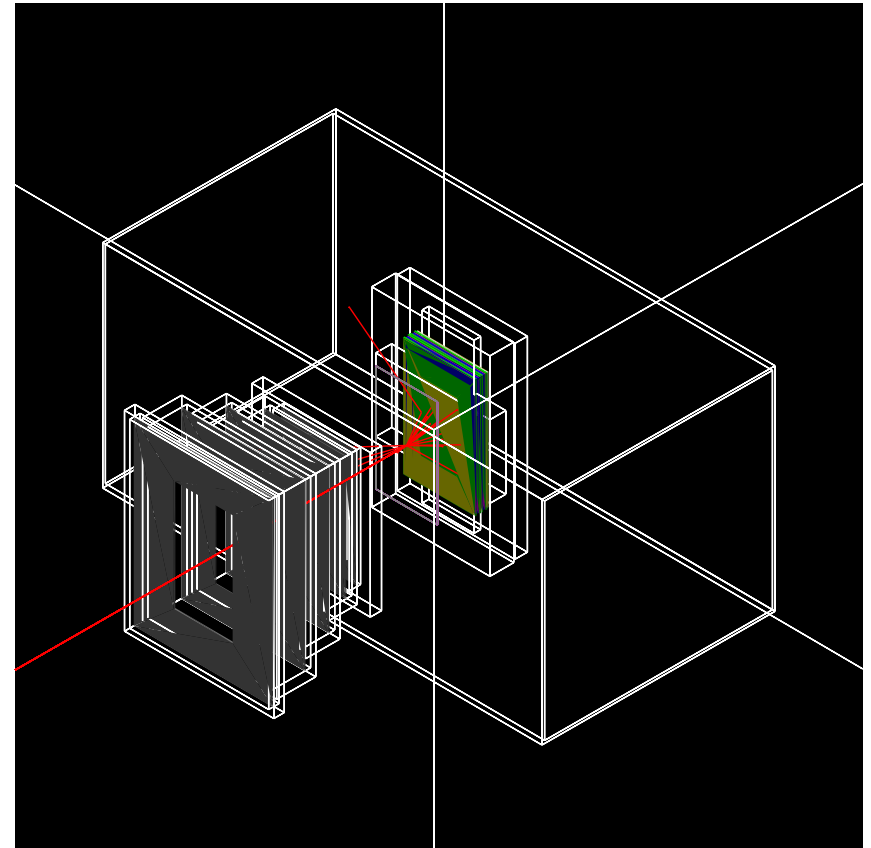

SST Electron Low Energy Defocusing

Low Energy-

Large angle scattered electrons
don't hit active area of detector
This spread reduces the
geometric factor

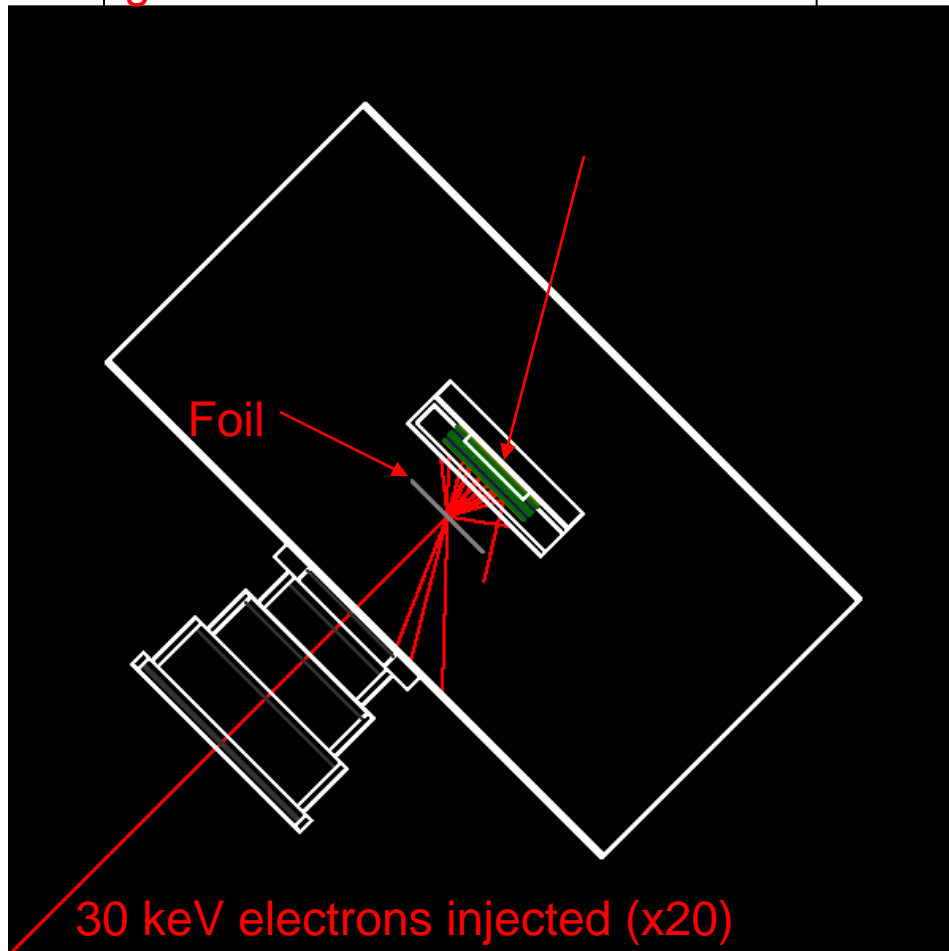

High Energy-

Smaller angle spread nearly
All electrons strike active area

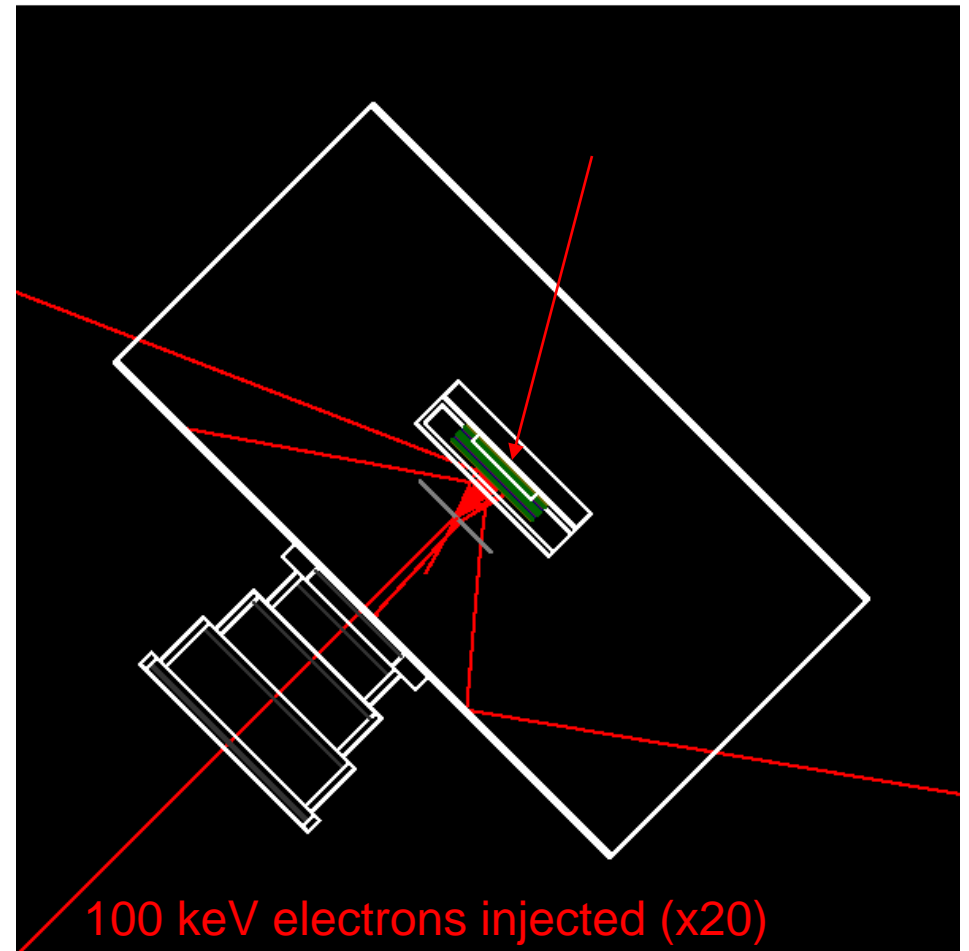

Simulated Instrument Response From CASINO

ENERGY LOST BY ELECTRON IN THE FOIL DETECTOR

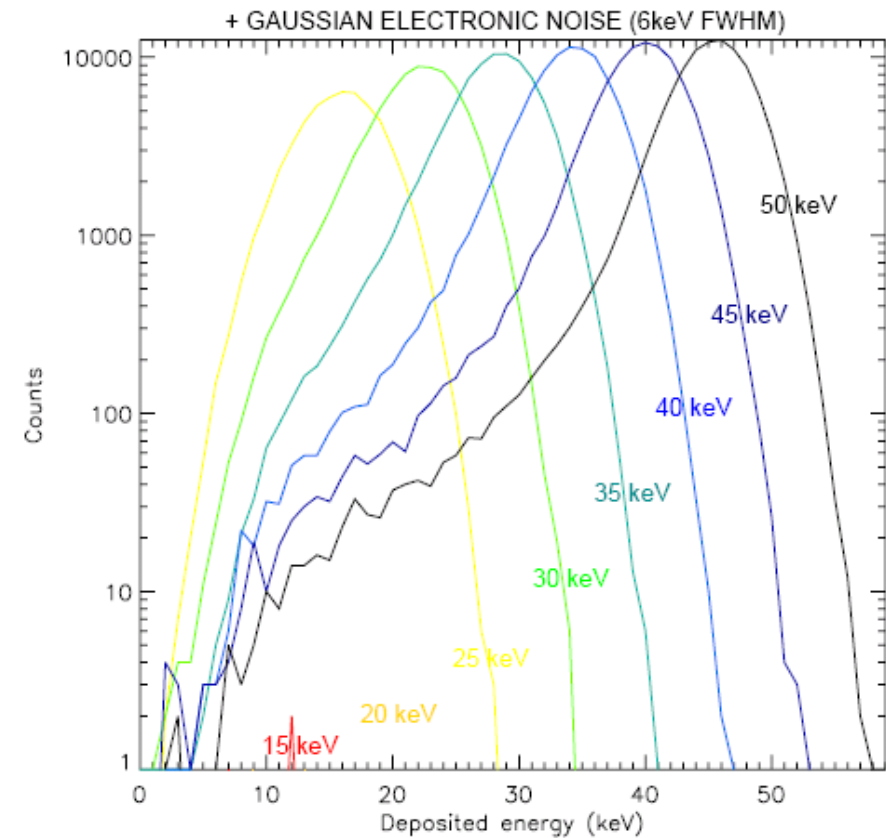
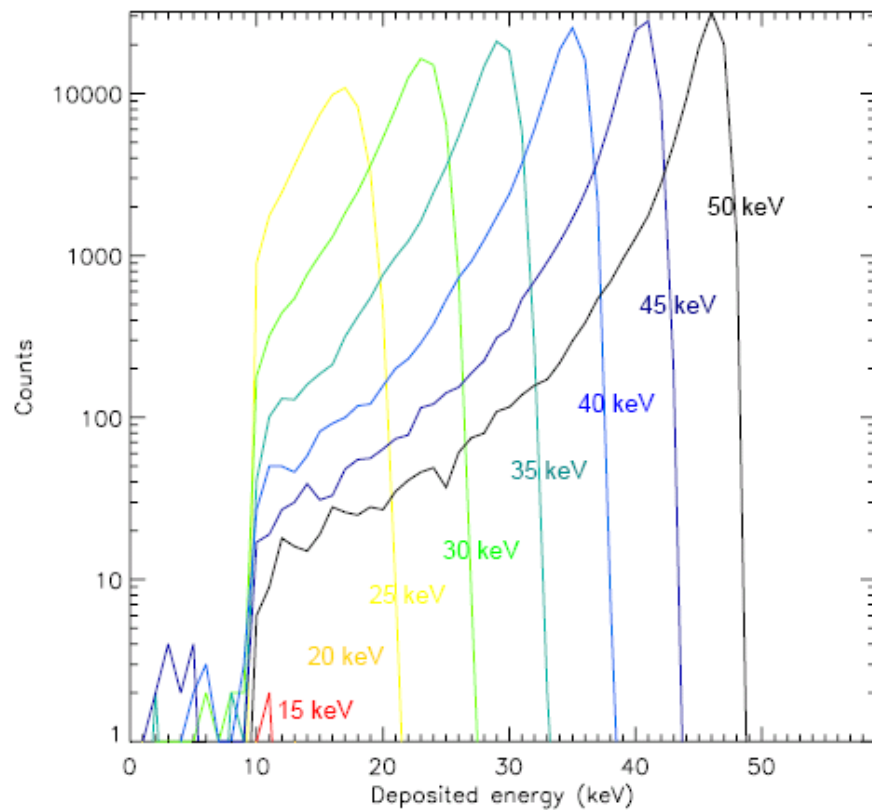

SST Electron sensor Calibrations

FLIGHT#2 – S3A Foil

C 2005-06-23/18:32:01 – 18:32:09

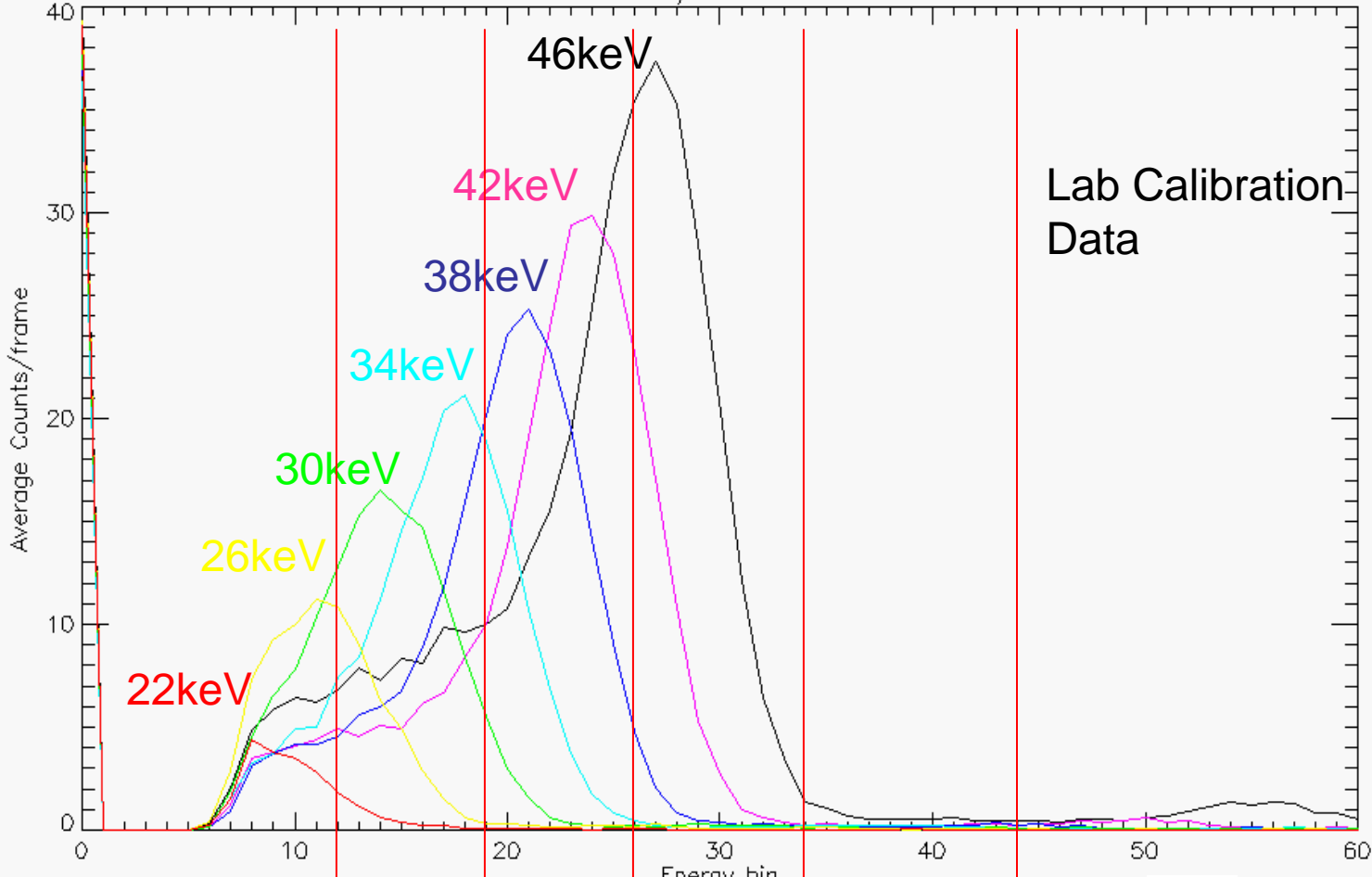

Programmed Energy Channels

E0 E1 E2 E3 E4

Applying Electron Scattering Correction

SST flux
Uncorrected

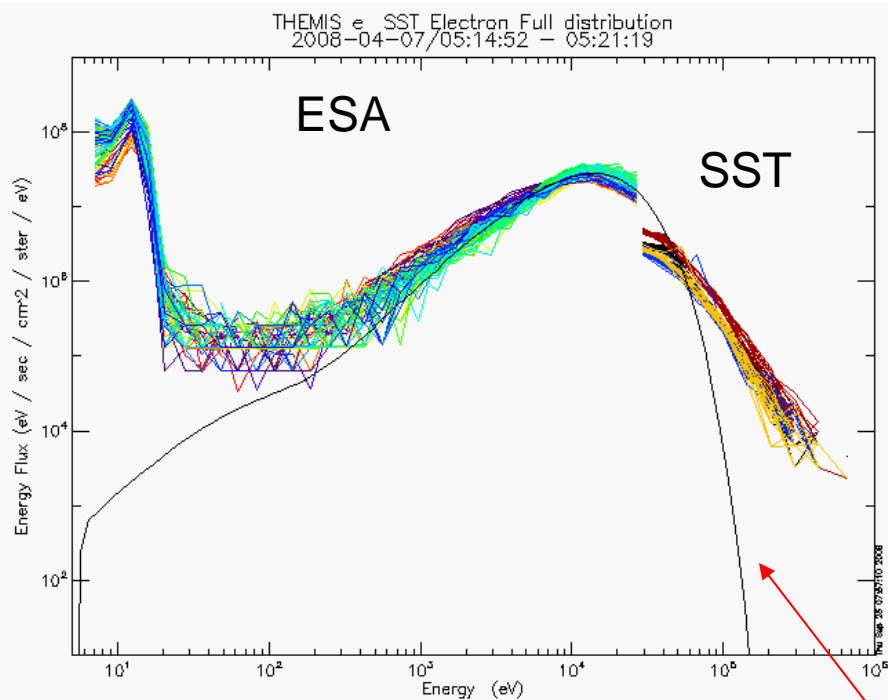

SST flux
Corrected

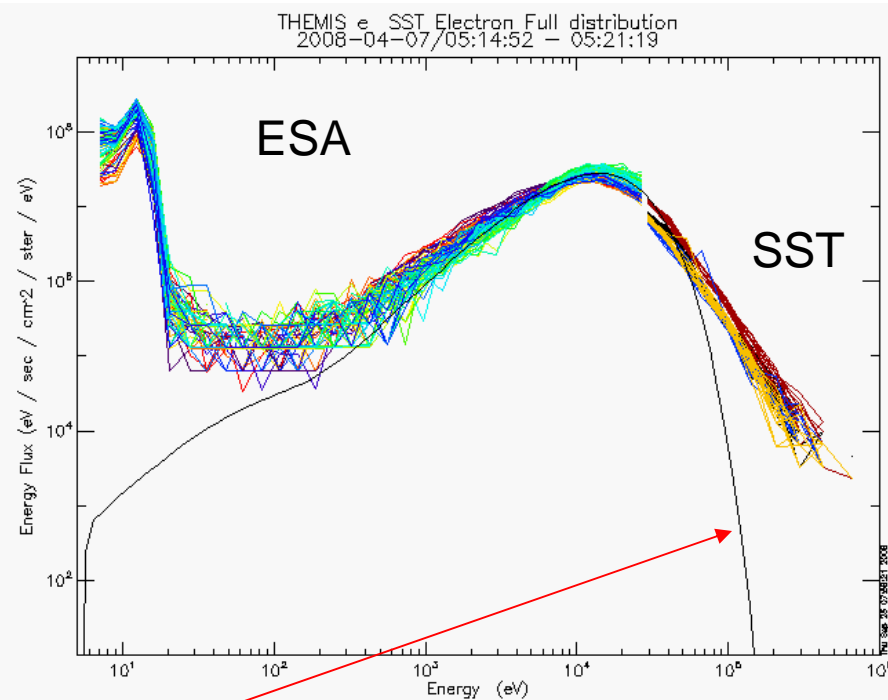

Model Maxwellian

THEMIS D_SST Electron Full distribution
2008-02-13/08:01:59 - 08:16:27

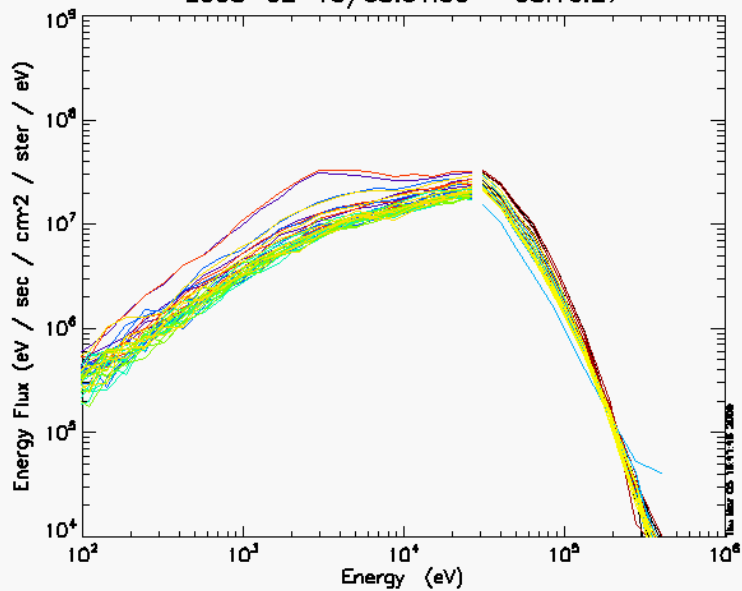

THEMIS D_SST Electron Full distribution
2008-02-13/11:47:48 - 12:02:16

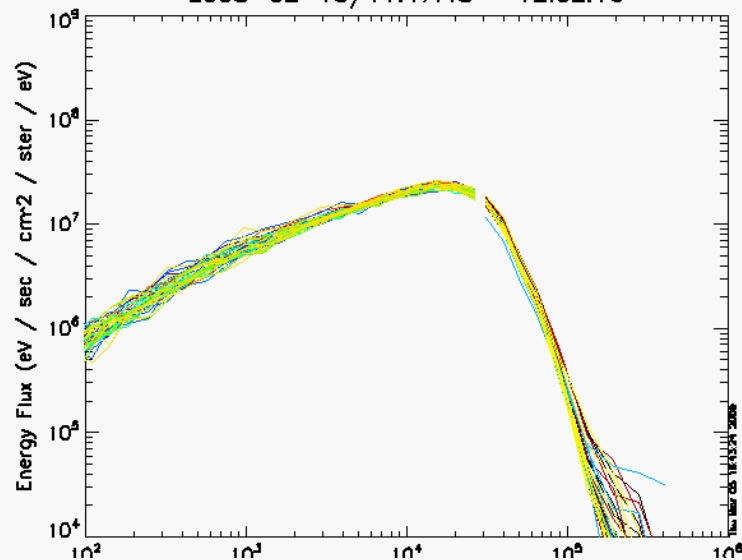

2008-02-13/10:03:42 - 10:18:10

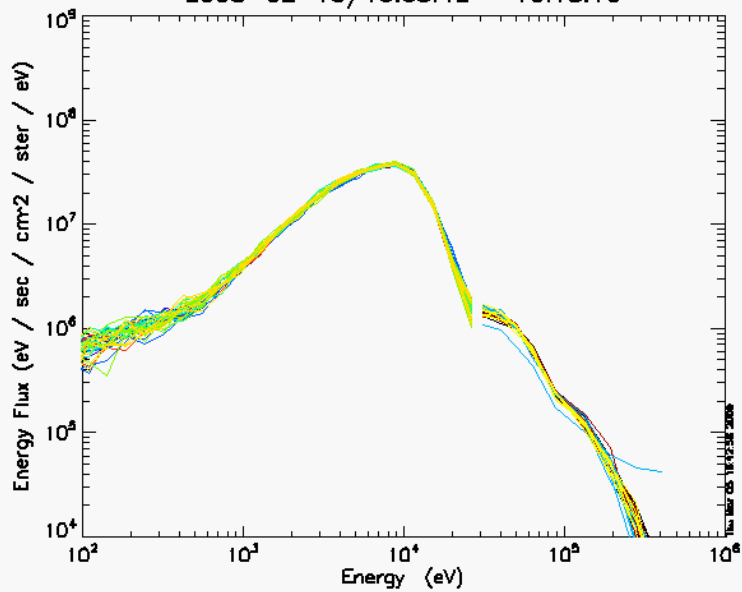

THEMIS D_SST Electron Full distribution
2008-02-13/08:43:37 - 08:58:05

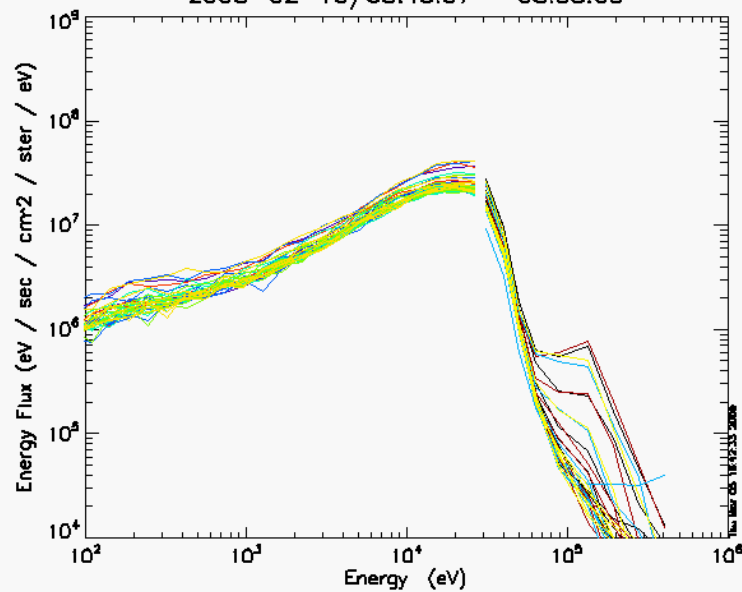

SST Measured Response to mono-energetic protons

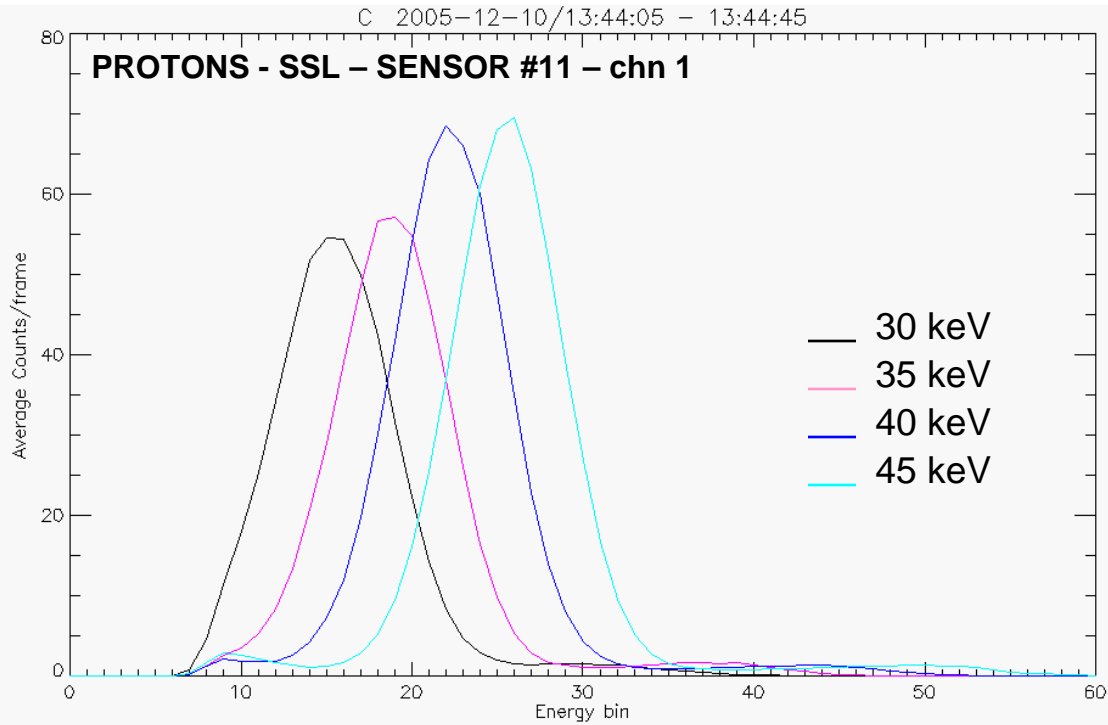

11-4 Proton response

6.5 keV of proton energy
Is lost while travelling through
Dead Layer (PRE-LAUNCH!)

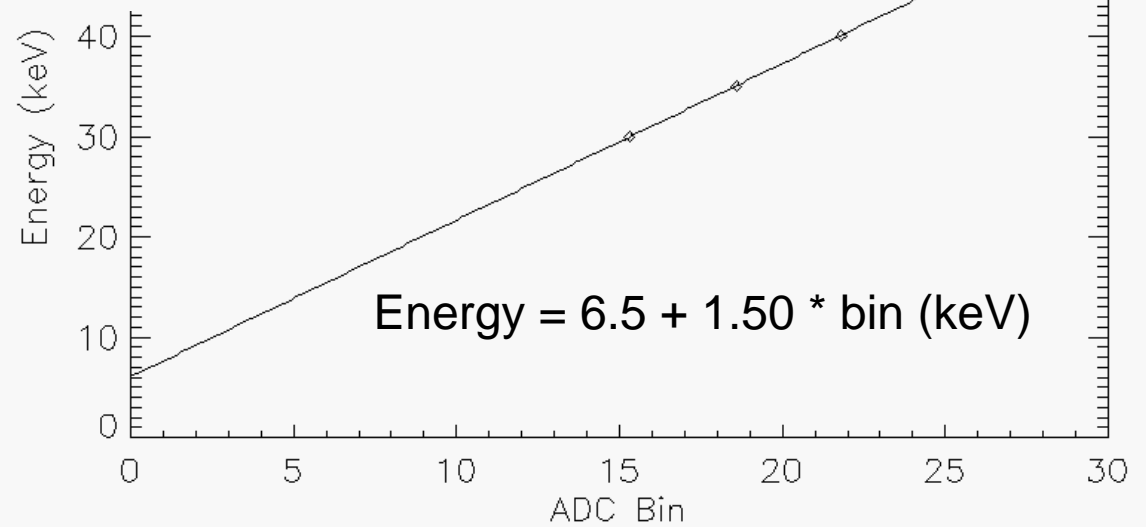

Calibration results

Typical Proton response
SST Sensor 05 - Channel 4

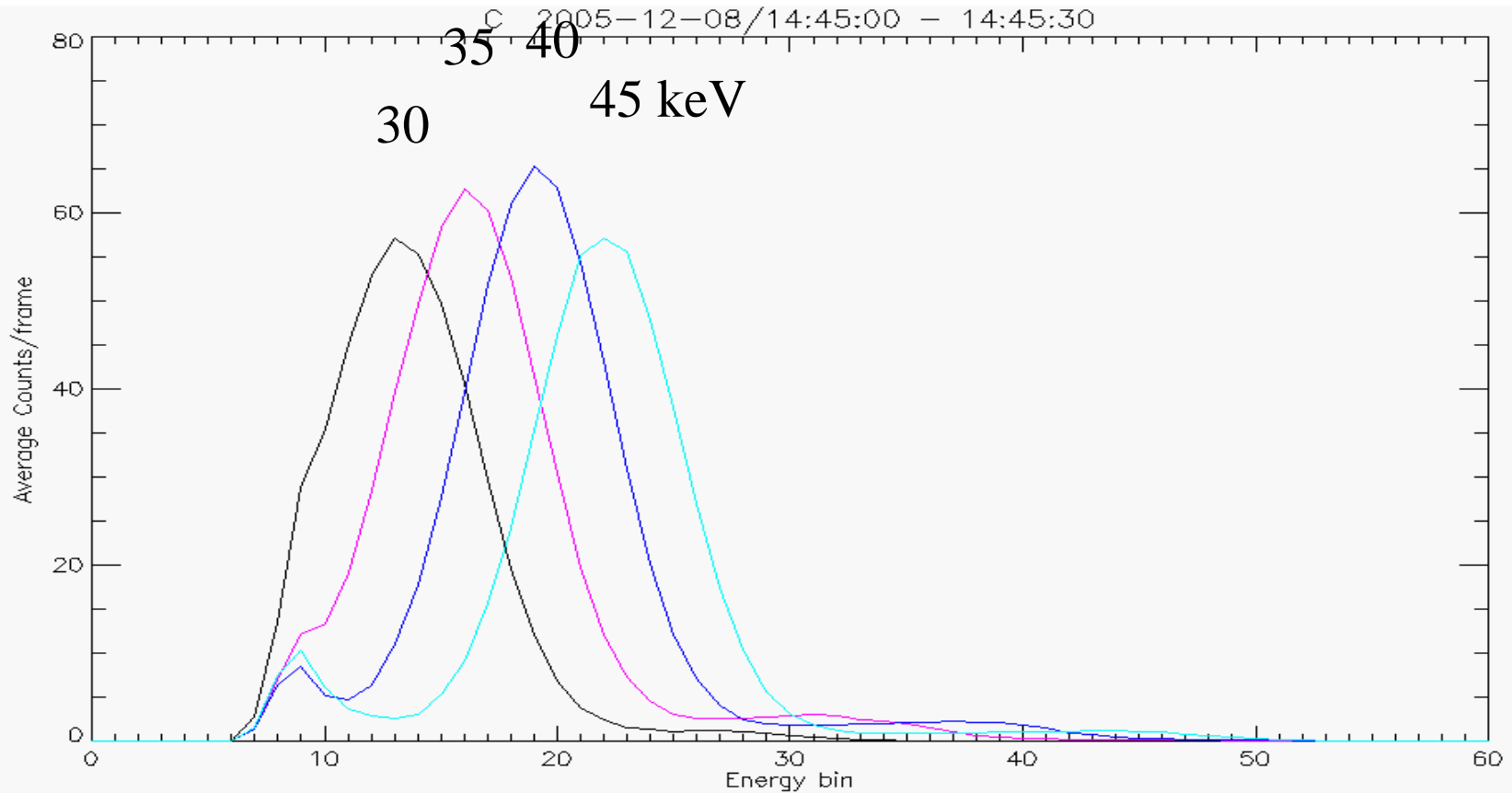

Dead Layer
(thickness
grows in time)

Solid state detectors
only measure the
energy deposited in the
active (depleted) region
of the silicon

As the dead layer grows
in time all energy
channels shift to higher
energy

Electric
field

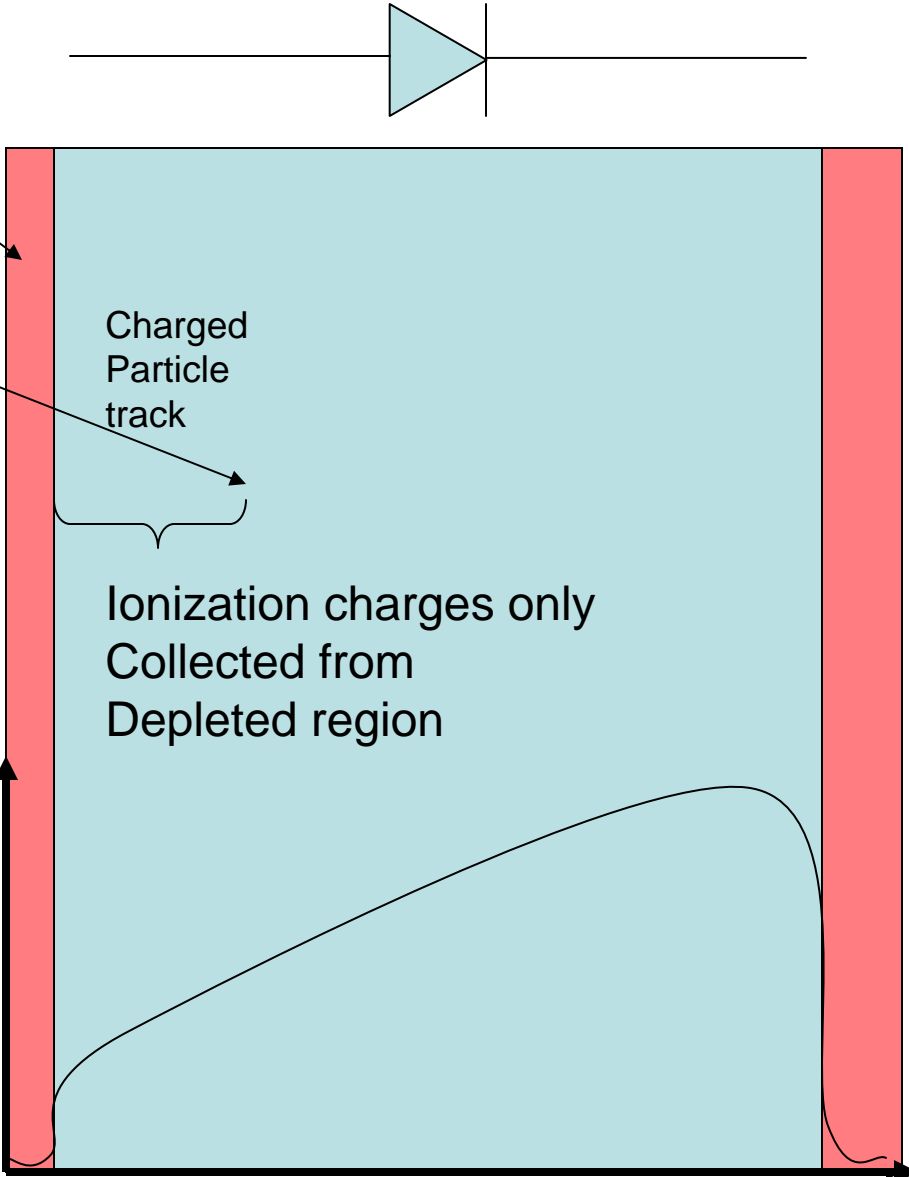

Distance

Correcting for increase in Dead layer

Themis E is shown

Themis B&C have much more severe damage

Ion Distribution

Uncorrected

Ion Distribution

Corrected

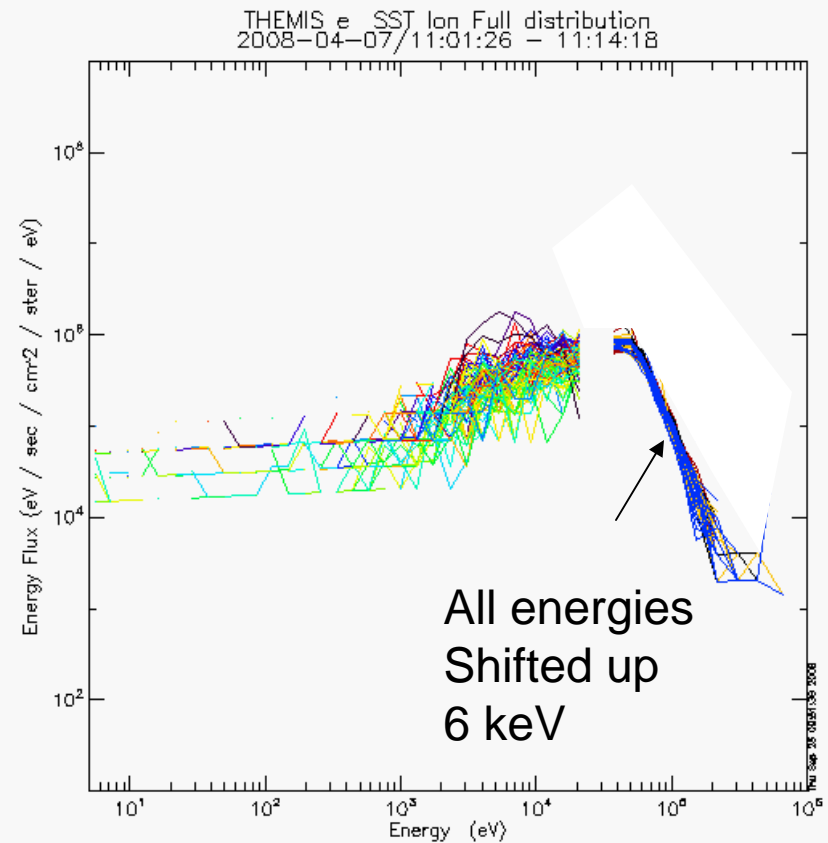
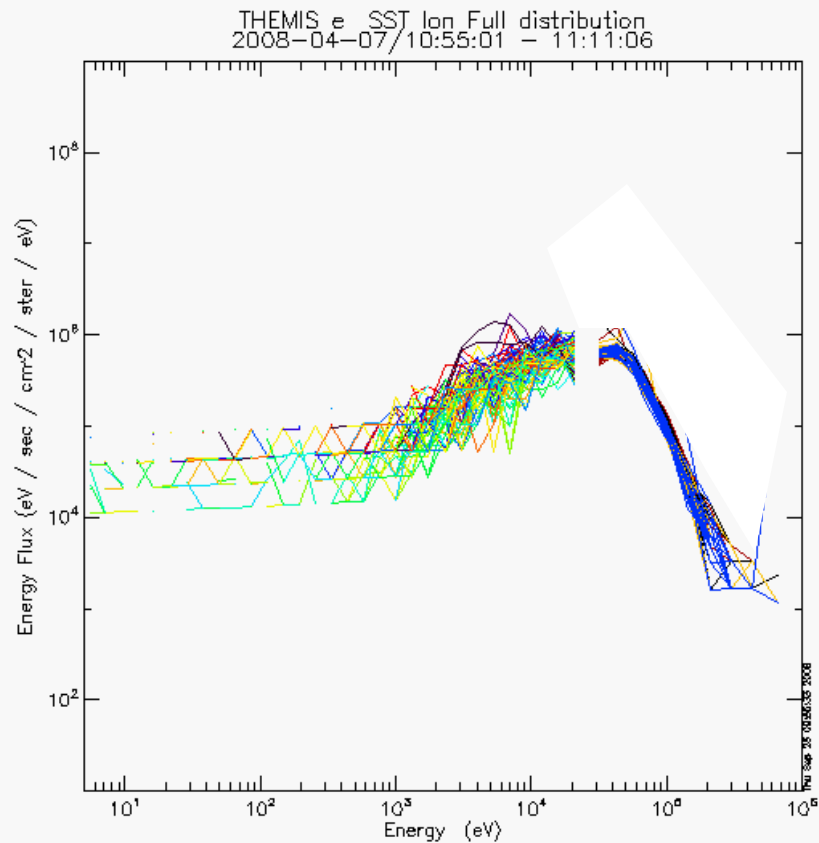

Summary

- THEMIS SST calibrations are still in progress. We feel we understand most anomalies
- If sun contaminated data bins are replaced with interpolated values then isotropic pressure calculations and velocity moments are trustworthy (spacecraft dependent)
- The ion detector degradation is not uniform
 - Spacecraft B&C have severe degradation
 - Spacecraft E has only moderate degradation
- Inter sensor calibrations are not (yet) good enough to trust details of pitch angle distributions
- See crib sheets for more details

THEMIS Data Availability

- All data is available directly at:
<http://themis.ssl.berkeley.edu/data>
- Three levels:
 - L0: Raw packet data- as produced on the spacecraft. Not useful to general public.
 - L1: Effectively equivalent to L0, but put in CDF files. Data is stored in raw (compressed) counts. No calibration factors applied. THEMIS mission specific software generally required to process this data into physical values.
 - L2: Processed data in physical units, but typically lacks the information needed for detailed study (i.e. lacks uncertainties, full 3D distributions). Files are periodically reprocessed as calibration parameters are updated and thus may require repeated downloads

THEMIS Software Availability

- All THEMIS software is available at:
http://themis.ssl.berkeley.edu/socware/bleeding_edge
- Software characteristics:
 - Written in IDL
 - Machine independent, Tested on Solaris/Linux/Windows/Mac
 - Automatically downloads data files as needed and creates a mirror cache on local system. Subsequent file access compares dates with remote server and only downloads if needed.
 - Layered/modular – File retrieval & data processing, data plotting & visualization, GUI interface are separate functions. Users can select the portions of the software they wish to use.
 - Library based. There is no “main” program. All software is provided as a collection of functions, procedures and example “crib sheets”

My recommendations

- Use the “bleeding edge” IDL software and use L1 data (the default)
 - Files are smaller than L2.
 - Files are stable (no need to redownload files as calibration parameters change)
 - Full access to 3D distributions for particles (not available with L2)
 - Visualization tools available
 - Use available “crib sheets” as examples
 - Commands (procedures and functions) can be used in your own private programs.

- DAP response was very linear except at very low energy.

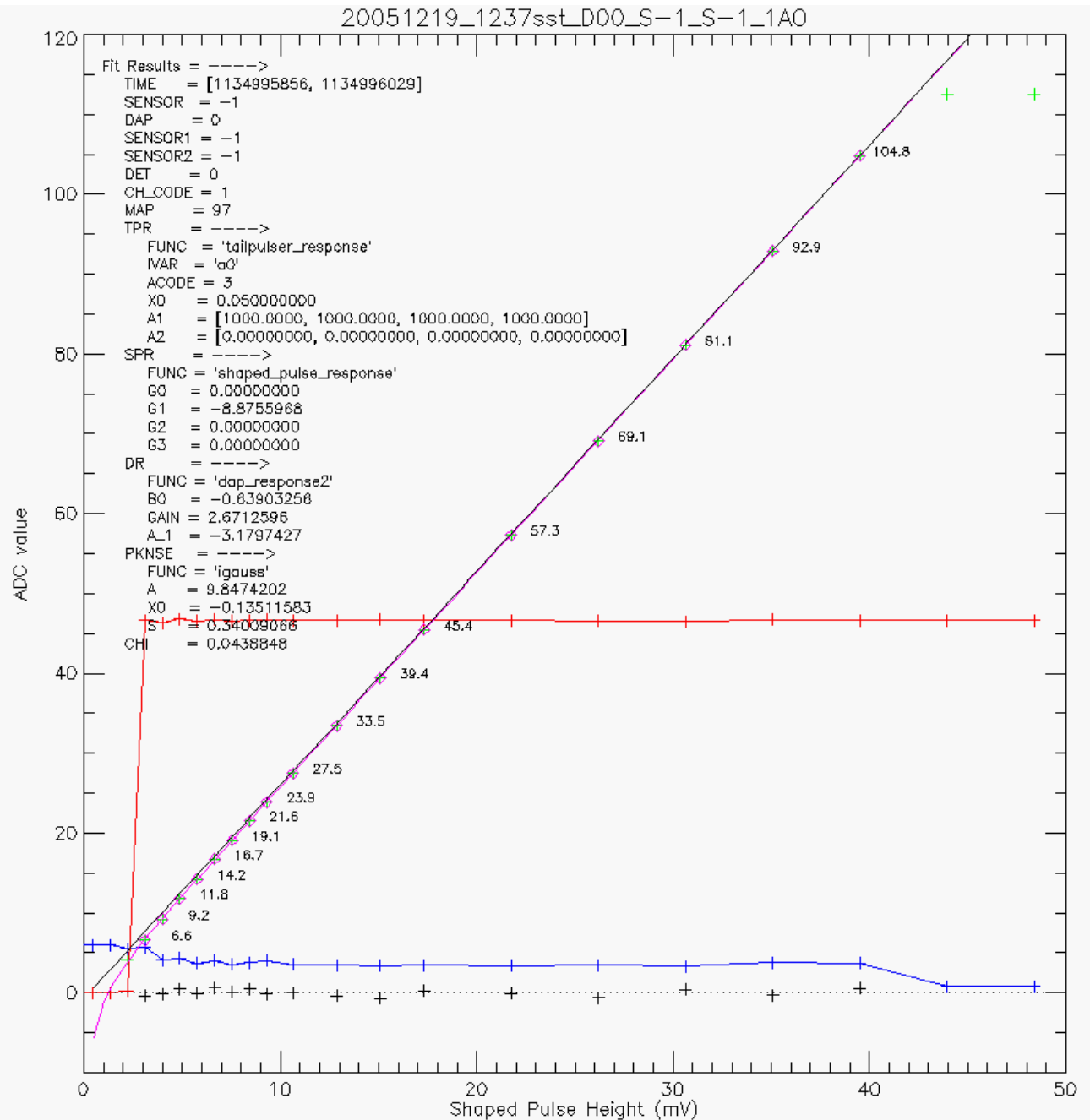

SST Programmed Energy Steps

SST Energy Steps		(Programable)							
Energy Step		Ion Packets		Middle	Electron Packets				
		Min ADC	Max ADC	Energy keV	Energy Step		Min ADC	Max ADC	Energy keV
-1		0		1.5			0		1.5
0	O	16	23	29.25	0	F	16	23	29.25
1	O	24	32	42	1	F	24	32	42
2	O	33	45	58.5	2	F	33	45	58.5
3	O	46	62	81	3	F	46	62	81
4	O	63	87	112.5	4	F	63	87	112.5
5	O	88	121	156.75	5	F	88	121	156.75
6	O	122	168	217.5	6	F	122	168	217.5
7	O	169	233	301.5	7	F	169	233	301.5
8	O	234	324	418.5	8	F	234	324	418.5
9	O	325	524	636.75	9	F	325	524	636.75
10	O	525	924	1086.75	10	F	525	824	1011.75
11	O	925	4095	3765	11	F	825	4095	3690
12	OT	0	3999	2999.25	12	FT	0	599	449.25
13	OT	4000	4095	6071.25	13	FT	600	999	1199.25
14	T	0	4095	ALL	14	FT	1000	4095	3821.25
15	FTO	2200	4095		15	FTO	0	2199	1649.25

Last 4 energy channels are used to store coincident events and should be ignored.

Warning this table uses early numbers (don't use)